

1/10TH ON ROAD STREET DRIFT CAR

EVO30



SET-UP INSTRUCTIONS &
EXPLODED DRAWINGS AND COMPONENT LISTING



THE HOBBYWING
ES6 INCLUDED

www.ftx-rc.com





FTX Evo30 1/10th On Road Street Drift Car

Congratulations on your purchase of the FTX 'Evo30' electric street drift car.

This 1/10th scale model has been factory assembled and all electrics installed and set up to make it the easiest possible introduction to the sport of driving RC cars.

WARNING: Read the ENTIRE instruction manual to become familiar with the features of the product before operating. Failure to operate the product correctly can result in damage to the product, personal property and cause serious injury.

This is NOT a toy and must be operated with caution and common sense.

Failure to operate this product in a safe and responsible manner could result in damage, injury or damage to other property.

This product is not intended for use by children without direct adult supervision. It is essential to read and follow all the instructions and warnings in the manual, prior to assembly, set-up or use, in order to operate correctly and avoid damage or serious injury.



Safety Precautions and Warnings

- You are responsible for operating this model such that it does not endanger yourself and others, or result in damage to the product or the property of others.
- This model is controlled by a radio which is possibly subject to interference which can cause momentary loss of control so it is advisable to always keep a safe distance to avoid collisions or injury.
- Age Recommendation: 14 years or over. This is not a toy. This product is not intended for use by children without direct adult supervision.

Carefully follow these directions and warnings, plus those of any additional equipment associated with the use of this model, chargers, ESC and motors, radio etc.

- Never operate your model with low transmitter batteries.
- Always operate your model in an open area away from cars, traffic or people.
- Never operate the model in the street or in populated areas.
- Always keep the vehicle in direct line of sight, you cannot control what you cannot see!
- Keep all chemicals, small parts and anything electrical out of the reach of children.
- Although splash-proof the car and electronics are not designed to be subjected to extended moisture exposure or submersion. To do so will result in permanent damage.
- Avoid injury from high speed rotating parts, gears and axles etc.
- Novices should seek advice from more experienced people to operate the model correctly and meet its performance potential.
- Exercise caution when using tools and sharp instruments.
- Do not put fingers or any objects inside rotating and moving parts.
- Take care when carrying out repairs or maintenance as some parts may be sharp.
- Do NOT touch equipment such as the motor, electronic speed control and battery, immediately after using your model because they can generate high temperatures.
- Always turn on your transmitter before you turn on the receiver in the car. Always turn off the receiver before turning your transmitter off.
- Keep the wheels of the model off the ground, and keep your hands away from the wheels when checking the operation of the radio equipment.
- Prolong motor life by preventing overheat conditions. Undue motor wear can result from frequent turns, rapid change of direction forwards/backwards, continuous stop/starts, pushing/pulling objects, driving in deep sand and tall grass, or driving continuously up hill.

Contents:

- FTX Evo30 Street Car (Brushless Edition)
- Transmitter – 2.4ghz Steerwheel
- Charger- 2S/3S balance Charger
- Battery – 2500mAH 7.4V 2S LiPo
- Drift Wheels & Tyre Set 4
- Front and rear Anti-Roll bars





REQUIRED EQUIPMENT FOR OPERATION

1. Tools required for building and maintenance:

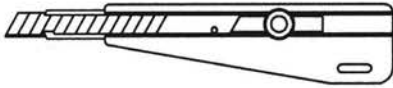

● Hobby knife

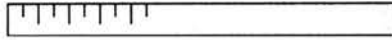

● Precision ruler

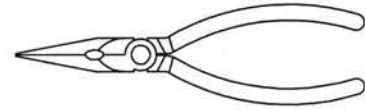

● Needle nose pliers

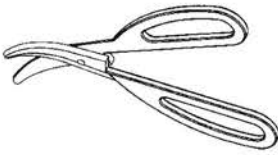

● Lexan scissors

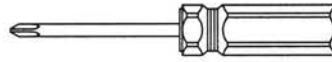
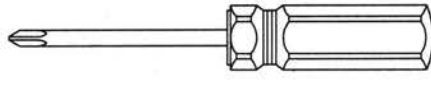

● Flat and Philips screwdriver

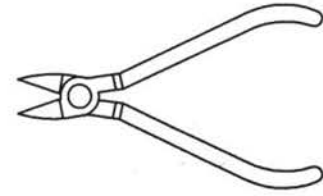

● Wire cutters

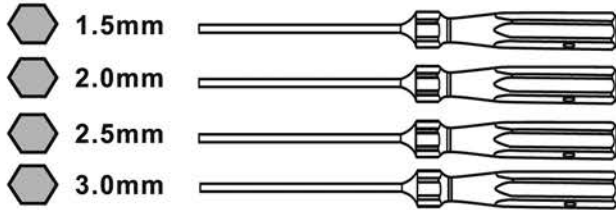

Hex. Screwdrivers

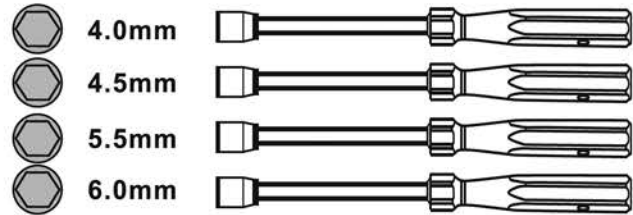

Socket Head Drivers

WARNING!

Do not use a power screw driver to install screws into nylon or plastic materials. The fast locking may heat up the screws being installed that may break the molded parts or strip the threads during installation.

2. Additional items needed for operation:

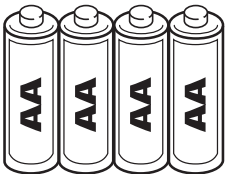

4 pcs AA Alkaline Batteries

IMPORTANT!

Check that all screws and nuts are tight before each use.



CHARGING/INSTALLING THE BATTERY - BRUSHLESS EDITION

IMPORTANT! ALWAYS CHARGE IN A LIPO SACK OR TIN AWAY FROM FLAMMABLE MATERIALS (SUCH AS CARPET). ALWAYS MONITOR CHARGE STATUS IN CASE YOU NEED TO STOP WITH IMMEDIATE EFFECT AND ALWAYS STORE YOUR MODEL WITH THE BATTERY UNPLUGGED AND REMOVED.

The included 900mAh mains LiPo balance charger will take up to 4 hours to re-charge the LiPo battery depending on how discharged it is. Before you start charging ensure that your LiPo battery is put inside the Voltz Vault safety LiPo sack.

(Lipo batteries can be dangerous and must be handled with care. Before commencing with charging ensure you familiarise yourself with our safety guidelines within the manual and on the base of the battery. Failure to do so could result in injury or damage. Lipo batteries require completely different charging and care than NiCd and NiMH batteries and must be used with a LiPo specific charger. Misuse can result in fire, personal injury and/or damage to property. The user assumes all liability and risk associated with the use of Lithium-Polymer (Li-Po) batteries. Immediately return the battery, unused, if you do not agree with these terms).

WARNING! NEVER LEAVE THE BATTERY UNATTENDED WHILE ON CHARGE.

- The supplied charger can charge either 2s or 3s (cell number) LiPo batteries. The supplied battery is a 3s. Ensure you plug it into the correct 3s balance port.
- When the charger is connected to the mains power the power LED will turn green. Once you connect your balance connector to the charger the status LED is RED, and power is GREEN indicating that charging is in progress. Once the battery is fully charged the two LED's will turn green. If you experience the LED's blinking red then there is an error with either the battery or charger. When charging a completely discharged battery, the charger can become hot to touch.
- Always disconnect the charger from the mains supply and the battery pack when not in use.
- To install a charged battery into the



vehicle, remove the body clips and remove the bodyshell. Loosen the velcro straps, insert battery and then tighten the straps so that they securely hold the battery inside the battery box. Make sure the model is switched off before connecting the male and female connectors.

- Always store your model with the battery pack unplugged and removed. Always charge your battery away from the vehicle.

Notes on Battery use:

- Always allow the battery cool after use, before recharging.
- Always inspect the battery before charging.
- Any bare wires, split heat shrink or leakage is a sure sign of abuse.
- Never attempt to charge dead or damaged batteries.
- Do not disassemble the battery or cut the connector wires.
- If the battery connector, battery case or cable insulation get hot enough to melt or split there is most likely a serious problem with your model, driveline, battery wires or speed controller. Find and correct the problem before installing another charged battery pack. (please refer to our detailed LiPo handling notes below).

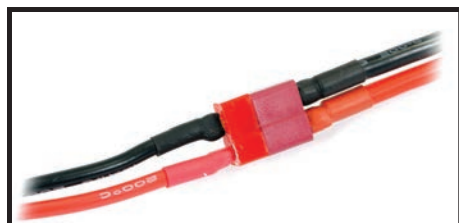
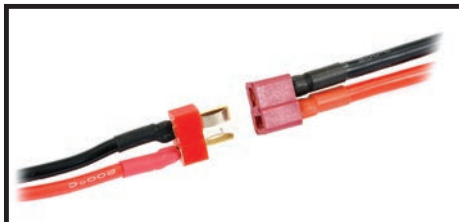

LIPO BATTERY - USER SAFETY AND HANDLING INSTRUCTIONS.

- Read all safety instructions before charging or using your batteries for the first time.
- Lipo batteries require completely different charging and care than NiCd and NiMH batteries.
- Misuse can result in fire, personal injury and/or damage to property. The buyer assumes all liability and risk associated with the use of Lithium-Polymer (Li-Po) batteries. Immediately return the battery, unused, if you do not agree with these terms.

General guidelines and warnings:

1. Use a Lithium Polymer specific chargers only! Do not use a NiCd or NiMH charger.
2. NEVER charge unattended. Always charge in safety sack or metal tin with lid and away from other flammable materials.
3. During the charge process watch for swollen or ballooning cells. If this happens immediately disconnect the charger and move the battery to a fire proof place for 15 minutes. Do not attempt to charge again.
4. A short circuit can cause a rapid discharge of high currents. Avoid short circuits, and be aware of short circuits on jewellery.
5. Any Lithium Polymer battery involved in a crash should be removed and observed in a fireproof space for 15 minutes before continuing to use or charge the battery.
6. If rewiring the battery pack, rewire the leads one at a time. Do not cut both leads. Do not short circuit on tools.
7. Do not expose battery packs to direct sunlight for extended periods.
8. Do not attempt to tamper with or open the LiPo Hardcase. The case is protection against possible battery swelling.

Before charging:

Visually inspect the pack checking for damaged leads, connectors, cracked heat shrink covering, swelling or other abnormalities. Do not charge if the pack is damaged.

Charging process:

1. NEVER charge unattended.
2. Charge away from flammable materials and inside a Lipo safe sack or metal tin with lid.
3. Allow battery to cool before charging.
4. Use the battery label for setting charger cell count and voltage.
5. Do not exceed 2C MAX charge rate. (Example, charge a 1000mAH pack at 5A MAX).

If disposing of a LiPo battery proceed as follows:

Submerge the battery into a container filled with about 10 litres of salt water (one cup of salt in 10L). Leave the battery submerged for 2 weeks, this will slowly and safely discharge the battery until the voltage has dropped to zero volts which eliminates the risk of any chemical reaction. It can then be disposed of in the general waste collection.



HOBBYWING BRUSHLESS SYSTEM SET-UP INSTRUCTIONS

1. Water-proof and dust-proof. The ESC can work under water for a short time.
(Please remove the cooling fan when running car in water, and after running, please make the ESC clean and then dry it to avoid the oxidation to copper connectors)
2. Specially designed for RC car and truck, with excellent start-up, acceleration and linearity features.
3. Drive sensorless brushless motors.
4. 2 running modes ("Forward with brake" mode, "Forward/Backward with brake" mode).
5. Proportional ABS brake function with 4 steps of maximum brake force adjustment, 8 steps of drag-brake force adjustment.
6. 4 start modes ("Punch") from "Soft" to "Very aggressive" to be suitable for different chassis, tires and tracks.
7. Multiple protection features: Low voltage cut-off protection for Lipo or NiMH battery / Over-heat protection / Throttle signal loss protection / Motor blocked protection.
8. Easily programmed with the "SET" button on the ESC or with the optional LED Program Card.

[SPECIFICATIONS]



Model	WP-S16-RTR	WP-S10C-RTR	WP-S10D-RTR WP-S10DS-RTR	WP-S10E-RTR	WP-10BL50-RTR (inc. speed control ver.)	WP-10BL60-RTR	
Cont./Burst	25A/90A	45A/260A	60A/390A	45A/220A	50A/300A	60A/390A	
Resistance	0.005 ohm	0.0012 ohm	0.0007 ohm	0.0012 ohm	0.0010 ohm	0.0012 ohm	
Car Applicable	1/18, 1/16 scale	1/10 scale on-road and off-road					
Motor Limit	2S Lipo 6 cells NiMH 2040 size motor	On-road: ≥ 12T Off-road: ≥ 18T 3650 size motor	On-road: ≥ 9T Off-road: ≥ 12T 3650 size motor	On-road: ≥ 5.5T Off-road: ≥ 9T 3650 size motor	On-road: ≥ 9T Off-road: ≥ 12T 3650 size motor	On-road: ≥ 8T Off-road: ≥ 11T 3650 size motor	On-road: ≥ 5.5T Off-road: ≥ 9T 3650 size motor
	3S Lipo 9 cells NiMH 2040 size motor	On-road: ≥ 18T Off-road: ≥ 24T 3650 size motor	On-road: ≥ 12T Off-road: ≥ 18T 3650 size motor	On-road: ≥ 8.5T Off-road: ≥ 13T 3650 size motor	On-road: ≥ 12T Off-road: ≥ 18T 3650 size motor	On-road: ≥ 11T Off-road: ≥ 14T 3650 size motor	On-road: ≥ 8.5T Off-road: ≥ 13T 3650 size motor
Battery	4-9 cells NiMH or 2-3S Lipo						
Rating Voltage of the Stock Cooling Fan (*Note 1)	Without cooling fan	5V	5V	7.4V	5V	5V	
Built-in BEC	6V/1A	6V/2A (Linear Mode)			6V/3A (Switch Mode)		
Program Port	Rx Wire	Multiplexed with cooling fan port					
Dimension/Weight	36*28*21 / 38g	49*34*35 / 75g	WP-S10D-RTR: 49*34*35 / 75g WP-S10DS-RTR: 49*32*41 /	48.5*38*32 / 90g	48.5*38*32 / 90g	48.5*38*32 / 90g	

* Note1:

- 1) The cooling fan on the WP-S16-RTR / WP-S10C-RTR / WP-S10D-RTR / WP-S10DS-RTR / WP-S10E-RTR ESC draws amperage directly from the battery pack, and the 5V fan can only work with a 2S LiPo / 4-6S NiMH battery pack. When using a 3S LiPo/7-9S NiMH battery pack, then the fan must be changed into a 7.4V/12V one.
- 2) The cooling fan on the WP-10BL50-RTR / WP-10BL60-RTR ESC is powered by the built-in BEC, so the 5V fan is OK and there is no need to consider if the input voltage is high or low.
- 3) In addition, please detach the fan from the ESC when running the vehicle in water/rain.

[BEGIN TO USE THE NEW ESC]

1. Connect the ESC, motor, receiver, battery and servo according to the following diagram

"+" and "-" wires of the ESC are connected with the battery pack, and #A, #B and #C are connected with the motor wires. The "SET" button is used for programming the ESC.

The control cable of the ESC (trio wires with black, red and white color) is connected with the throttle channel of the receiver (Usually CH2).

The #A, #B, #C wires of the ESC can be connected with the motor wires freely (without any order). If the motor runs in the opposite direction, please swap any two wire connections.

Note: You can use the transmitter to set the throttle channel to

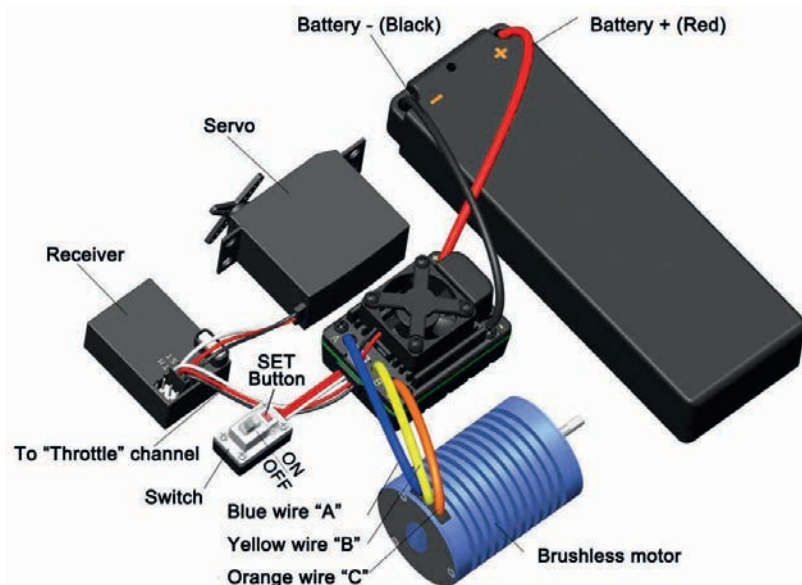



the "Reverse" direction, and then the motor will run oppositely. Please calibrate the throttle range again after changing the direction of throttle channel.

2. Throttle Range Setting (Throttle Range Calibration)

In order to make the ESC match the throttle range, you must calibrate it when you begin to use a new ESC, or a new transmitter, or after changing the settings of the neutral position of throttle channel, ATV or EPA parameters, otherwise the ESC cannot work properly.

There are 3 points need to be set, they are the top point of "forward," backward" and the neutral point.

The following pictures show how to set the throttle range with a Futaba™ transmitter.

- A) Switch off the ESC, turn on the transmitter, set the direction of throttle channel to "REV", set the "EPA/ATV" value of throttle channel to "100%", and disable the "ABS" brake function of your transmitter. (*Note2)
- B) Hold the "SET" key and then switch on the ESC, when the red LED begins to flash, release the key immediately. (Please check the picture on the right side)

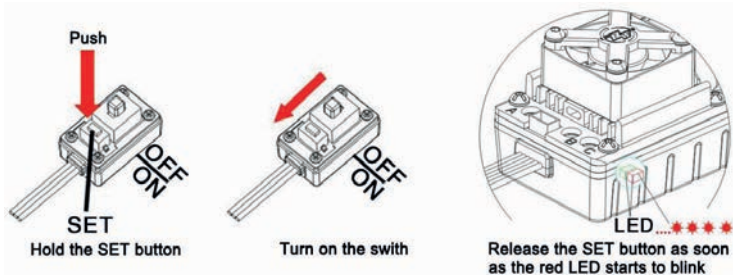

- C) Set the THREE points according to the steps shown in the picture on the right side.
- 1) Neutral point
 - 2) End point of forward direction
 - 3) End point of backward direction
- D) When the process of calibration is finished, the motor can be started after 3 seconds.

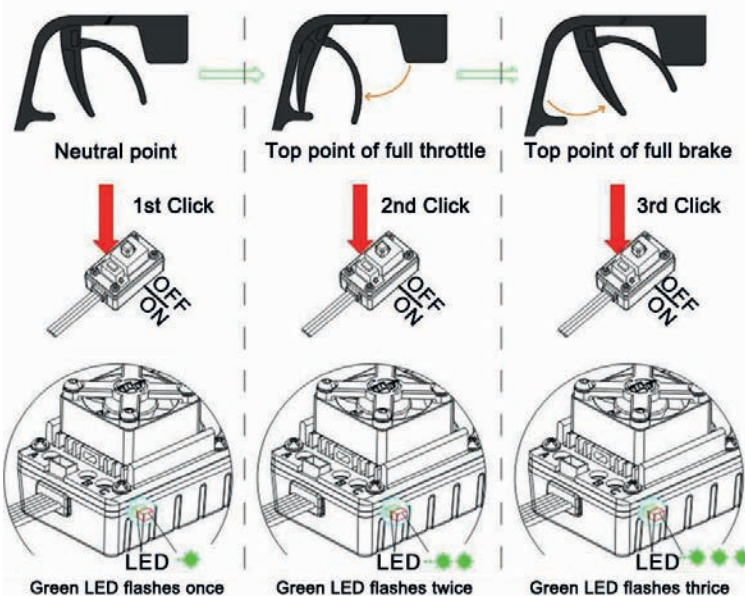

Note2: If you don't release the "SET" key after the red LED begins to flash, the ESC will enter the program mode, in such a case, please switch off the ESC and re-calibrate the throttle range again from step A to step D.

3. The LED Status in Normal Running

- a) When the throttle stick is in the neutral range, neither the Red LED nor the Green LED lights up.
- b) When the car moves forward, the Red LED solidly lights; the Green LED also lights up when the throttle stick is at the top position (100% throttle).
- c) When the car brakes, the Red LED solidly lights; the Green LED also lights up when the throttle stick is at the bottom position and the maximum brake force is set to 100%.
- d) When the car reverses, the Red LED solidly lights.

[ALERT TONES]

1. Input voltage abnormal alert tone: The ESC begins to check the input voltage when power on, if it is out of the normal range, such an alert tone will be emitted: "beep-beep-, beep-beep-, beep-beep-" (There is 1 second time interval between every "beep-beep-" tone).
2. Throttle signal abnormal alert tone: When the ESC can't detect the normal throttle signal, such an alert tone will be emitted: "beep-, beep-, beep-" (There is 2 seconds time interval between every "beep-" tone).

[PROTECTION FUNCTION]

1. Low voltage cut-off protection: If the voltage of a Lipo battery pack is lower than the threshold for 2 seconds, the ESC will cut off the output power. Please note that the ESC cannot be restarted if the voltage of each Lipo cell is lower than 3.5V.
For NiMH battery packs, if the voltage of the whole NiMH battery pack is higher than 9.0V but lower than 12V, it will be considered as a 3S Lipo; If it is lower than 9.0V, it will be considered as a 2S Lipo. For example, if the NiMH battery pack is 8.0V, and the threshold is set to 2.6V/Cell, it is considered as a 2S Lipo, and the low-voltage cut-off threshold for this NiMH battery pack is 2.6*2=5.2V.
2. Over-heat protection: When the temperature of the ESC is over a factory preset threshold for 5 seconds, the ESC will cut off the output power. You can disable the over-heat protection function for competition race.



3. Throttle signal loss protection: The ESC will cut off the output power if the throttle signal is lost for 0.2 second.

[PROGRAM THE ESC]

1. Program Method

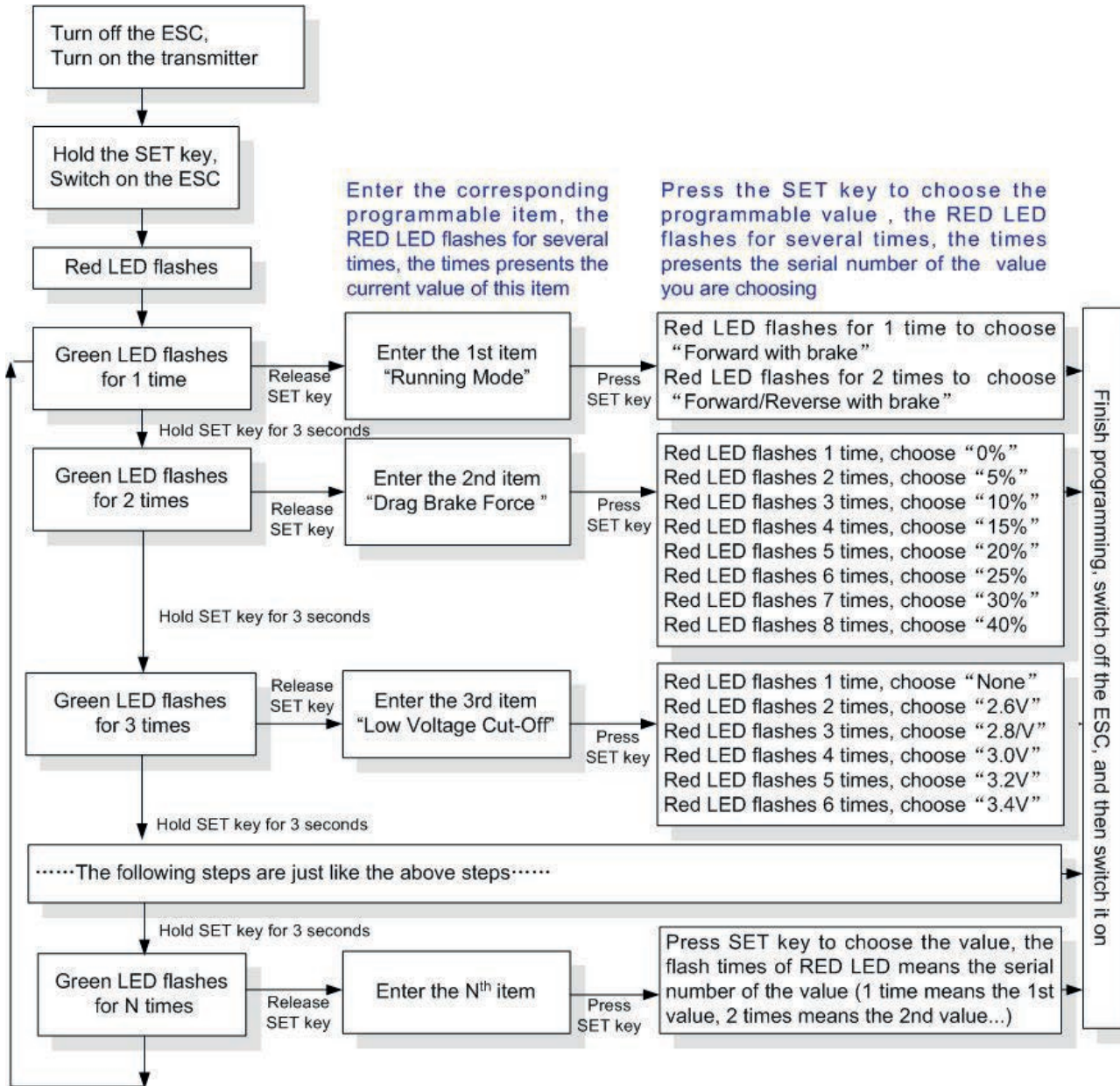

Note:

- ☒ In the program process, the motor will emit “Beep” tone when the LED is flashing.
- ☒ The 5th programmable item is represented by 5 short Beeps (that is, “BBBBB”).
- ☒ For the options of each programmable item, we use a long time flash and long “Beep---” tone to represent number “5”, so it is easy to identify the options with big numbers.

For example, if the LED flashes as the following:

“A long time flash” (Motor sounds “B---”) = The option 5

“A long time flash + a short time flash” (Motor sounds “B---B”) = The option 6

“A long time flash + 2 short times flash” (Motor sounds “B---BB”) = The option 7

“A long time flash + 3 short times flash” (Motor sounds “B---BBB”) = The option 8



2. Programmable Items list

Programmable Items	Programmable Value							
	1	2	3	4	5	6	7	8
1. Running Mode	Forward with Brake	<i>Forward/Reverse with Brake</i>						
2. Drag Brake Force	<i>0%</i>	5%	10%	15%	20%	25%	30%	40%
3. Low Voltage Cut-Off Threshold	Non-Protection	2.6V /Cell	2.8V /Cell	<i>3.0V /Cell</i>	3.2V /Cell	3.4V /Cell		
4. Start Mode (Punch)	Level1 (Soft)	Level2	<i>Level3</i>	Level4 (Very Aggressive)				
5. Maximum Brake Force	25%	50%	<i>75%</i>	100%				

Attention: The italic texts in the above form are the default settings.

3. Programmable Items

3.1. Running Mode: With "Forward with Brake" mode, the car can go forward and brake, but cannot go backward, this mode is suitable for competition; "Forward/Reverse with Brake" mode provides backward function, which is suitable for training.

Note: "Forward/Reverse with Brake" mode uses "Double-Click" method to make the car go backward. When you move the throttle stick from forward zone to backward zone for the first time, the ESC begins to brake the motor, the motor speeds down but it is still running, not completely stopped, so the backward action is NOT happened now. When the throttle stick is moved to the backward zone again (The 2nd "click"), if the motor speed is slowed down to zero (i.e. stopped), the backward action will be occurred. The "Double-Click" method can prevent mistakenly reverse when the brake function is frequently used in steering.

3.2. Drag Brake Force: Set the amount of drag brake applied at neutral throttle to simulate the slight braking effect of a neutral brushed motor while coasting.

3.3. Low Voltage Cut-Off: The function is mainly used to prevent the Lipo battery from over discharging. The ESC monitors the battery's voltage at any time, if the voltage is lower than the threshold, the output power will be reduced to 50% in 2 seconds. Please drive to the side of racing track as soon as possible and then stop the car, the ESC will completely cut off the output power in 10 seconds. The values listed in the table refer to the cut-off threshold for each Lipo cell.

3.4. Start Mode (Also called "Punch"): Select from "Level1 (Soft)" to "Level 4 (Very aggressive)" start mode as you like. Please note that if you choose "Level 4 (Very aggressive)", you should use good quality battery with powerful discharge ability, otherwise you cannot get the bursting start effect as you want. If the motor cannot run smoothly (that is: the motor is trembling), it may caused by the weak discharge ability of the battery, please choose a better battery or increase the gear rate.

3.5. Maximum Brake Force: The ESC provides proportional brake function. The brake force is related to the position of the throttle stick. Maximum brake force refers to the force when the throttle stick is located at the top point of the backward zone. A very large brake force can shorten the brake time, but it may damage the gears.

4. Reset All Items To Default Values

At any time when the throttle is located in neutral zone (except in the throttle calibration or programming mode), hold the "SET" key for over 3 seconds, the red LED and green LED will flash at the same time, which means each programmable item has been reset to its default value. It needs to be restarted to complete the whole process.

[OPTIONAL ACCESSORIES]

We provide the following optional accessories:

1. Cooling fan (12V): The high voltage fan is an option when you use 3S Lipo or NiMH battery more than 6 cells.

WARNING! Please note the original cooling fan (5V) is only allowed to work with 2S Lipo or 4-6 cells NiMH battery. Please DON'T use it with a 3S Lipo or NiMH battery more than 6 cells.

2. LED Program Card (Digital LED Display)

The LED Program Card is an optional accessory which needs to be purchased separately. It has a friendly user interface. The process of programming the ESC becomes quite easy and fast with this pocket sized device.

Please connect the ESC to LED Program Card via the program port.

☒ For WP-S16-RTR ESC, the program port is multiplexed with the Rx wire, please

Mark: Direction of the airflow and the impeller

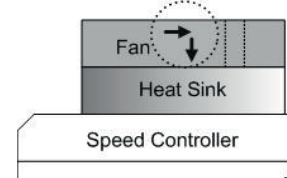



disconnect the Rx wires from receiver and then connect it to LED program card.

- For WP-S10C, WP-S10D, WP-S10DS, WP-S10E, WP-10BL60 ESC, the program port is multiplexed with the cooling fan port, please disconnect the cooling fan, and then use program cable to connect the fan port of the ESC to the LED program card.

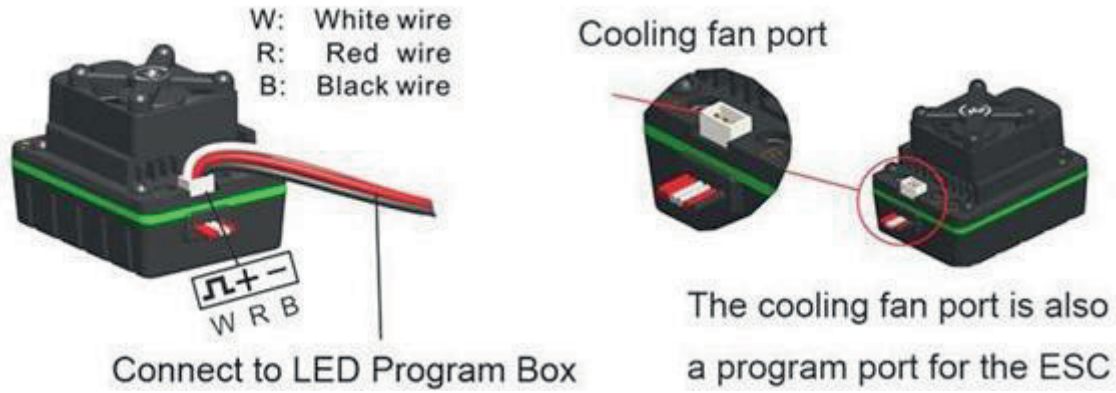

【TROUBLE SHOOTING】

Trouble	Possible Reason	Solution
After power on, motor can't work, no sound is emitted	The connections between battery pack and ESC are not correct	Check the power connections Replace the connectors
After power on, motor can't work, but emits "beep-beep-, beep-beep-" alert tone. (Every "beep-beep-" has a time interval of 1 second)	Input voltage is abnormal, too high or too low.	Check the voltage of the battery pack
After power on, motor can't work, but emits "beep-, beep-, beep-" alert tone. (Every "beep-" has a time interval of about 2 seconds). And the red LED solid lights	Throttle signal is abnormal	Check the transmitter and the receiver Check the wire of the throttle channel
After power on, motor can't work and the red LED blinks very quickly	The neutral point of the throttle channel is changed	Calibrate the throttle range for the ESC again, or adjust the trimmer of throttle channel (on the transmitter) to change the neutral point.
The motor runs in the opposite direction	The wire connections between ESC and the motor need to be changed	Swap any two wire connections between the ESC and the motor.
The motor suddenly stops running while in working state	The throttle signal is lost	Check the transmitter and the receiver Check the wire of the throttle channel
	The ESC has entered the Low Voltage Protection Mode	Replace the battery pack
Random stop or restart or irregular working state	Some connections are not reliable	Check all the connections: battery pack connections, throttle signal wire, and motor connections, etc.
	There is strong electro - magnetic interference in flying field.	Reset the ESC. If the function could not be resumed, you might need to move to another area to run the car.



Electric Scheme of installation

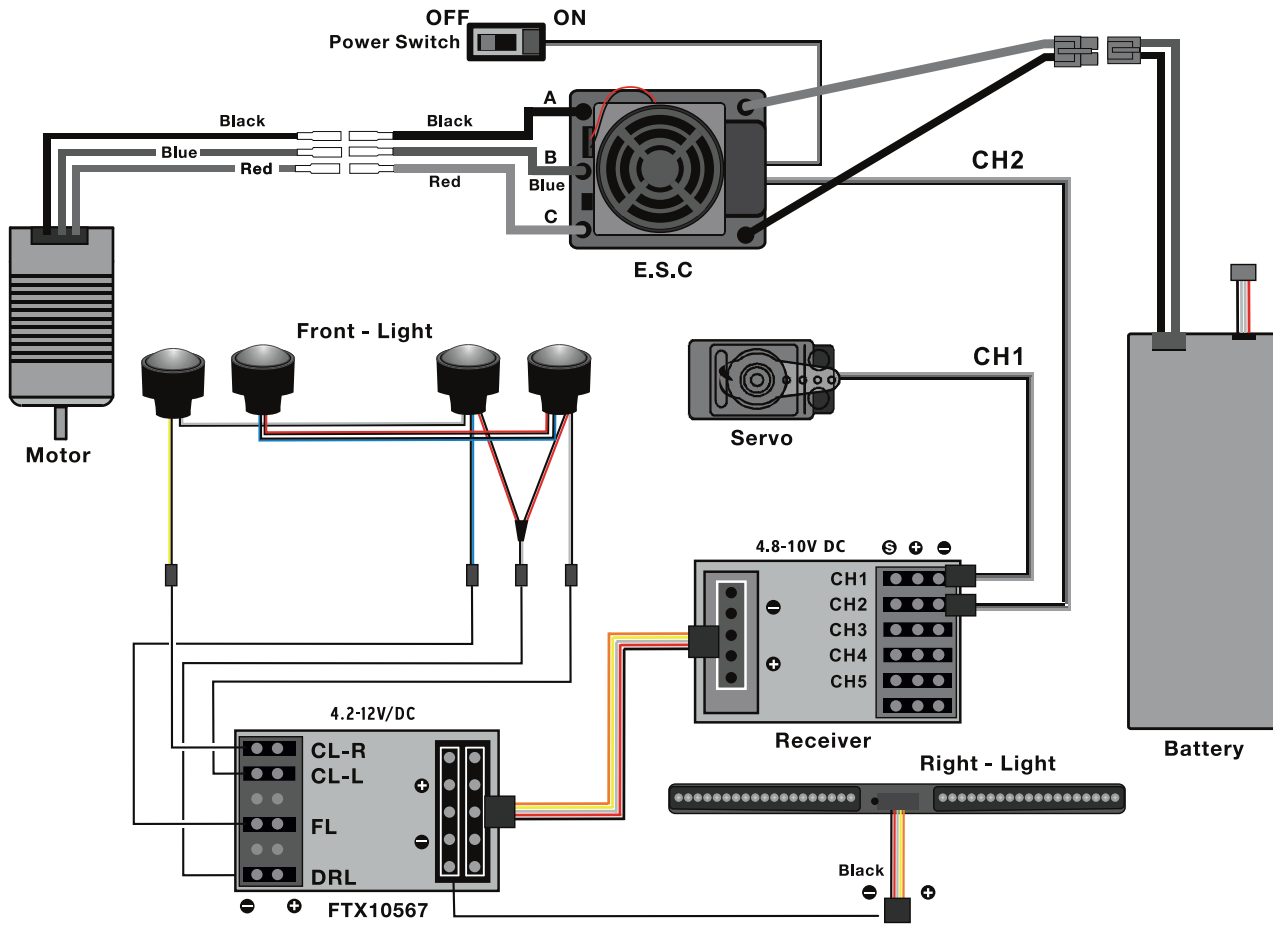

Note: please connect the light group according to the wiring diagram. No light on, please check the connector, and adjust the positive and negative ports. The light group could not be damaged when the positive and negative pole in incorrect position.

2.4GHZ Radio System

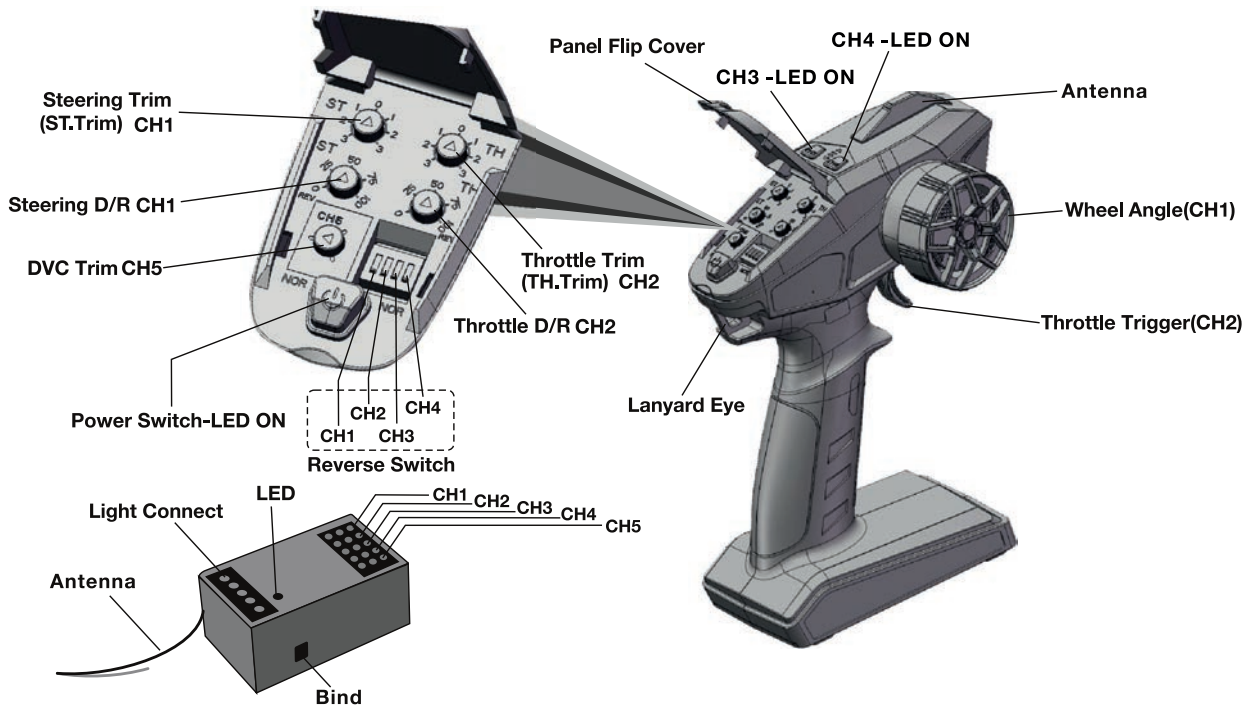



Install The Transmitter Batteries

Battery Installation:

1. Open the battery compartment cover.
2. Insert 4 AA fully charged batteries or 2S Li-Po batteries in correct polarity.
(No response if battery polarity reversed.)
3. Close battery compartment cover.

Batteries: 4 x 1.5 V "AA"
(not included)

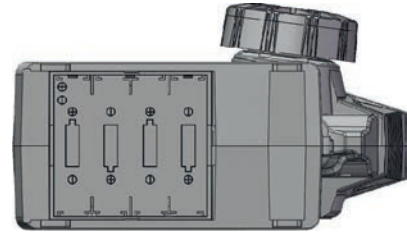
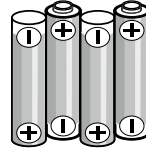

Binding Process:

1. Press receiver button, the LED indicator will flash quickly meaning it is entering the binding mode.
the receiver will automatically look for the nearest transmitter signal.
2. The indicator will always be ON after a successful bind

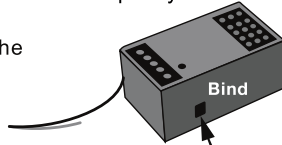

DVC Gyroscope Setting (Brushless Version ONLY)

1. The Gyroscope start function is set at the factory. Continually press the Receiver BIND button three times, the LED flashes, the Gyroscope function turns off. Then press the Reciver BIND button three times again, the LED flashes, the Gyroscope function turns on.
2. Gyroscope function sensitivity is controlled by the Transmitter CH5 key (as shown in picture). Turn the knob in clockwise direction, the sensitivity increases, when turn knob in counterclockwise direction, the sensitivity becomes weaker.

Check the steering after vehicle is bound with transmitter.

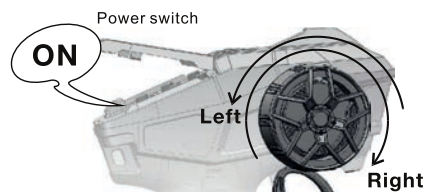

Wheel Angle,
the maximum rotation of the
Steering wheel is 35 degrees From center to left or right .

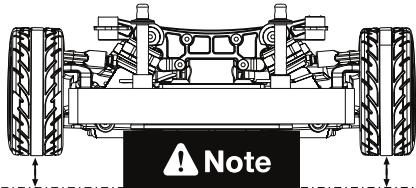

Note

Place the vehicle on the stand with four wheels off ground as shown.

The ST.TRIM is the trims for Ch1(steering). You can trim the Steering Trim until it fulfills your desired steering angles.

ST.D /R is for servo travel adjustment, which can be multiplexed as CH2 (throttle), CH3, CH4 servo travel adjustment.

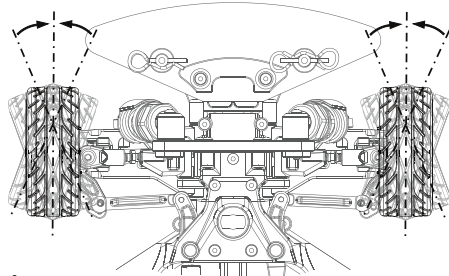

Note

- Please trim the Throttle Trim (TH. Trim) until the vehicle stops in case the vehicle goes forwards or backwards itself just after it is turned on.
- If the front wheels are not aligned, please trim "steering trim" (ST.TRIM) until they are aligned.

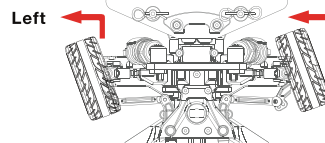

Left

Move the control wheel to the left, vehicle turns left.

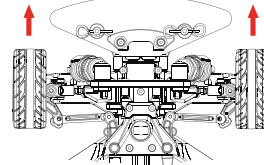

Do not move the control wheel, the front wheels are aligned and the vehicle goes straight in line.

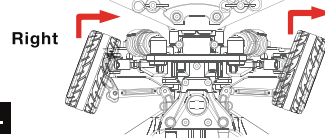

Right

Move the control wheel to the right, vehicle turns right.

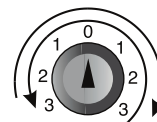

(ST.TRIM)

ST.TRIM / R : increase adjustment step
ST.TRIM / L : Decrease adjustment step

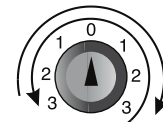

(TH.TRIM)

TH.TRIM / R : increase adjustment step
TH.TRIM / L : Decrease adjustment step

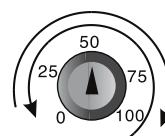

(Steering D/R)

STD / R + : increase servo travel.
STD / R - : decrease servo travel.

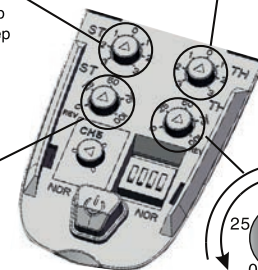

(Throttle D/R)

TH.D / R + : increase throttle travel.
TH.D / R - : decrease throttle travel.



Pull the trigger to go forwards, push it to brake, center the trigger and then push it again to go backwards.

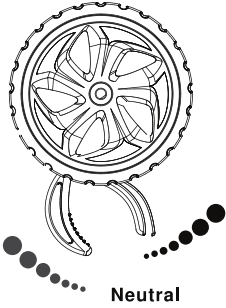

Throttle trigger,
has a total throw of 12 degrees,
12.5 degrees forward,
and 12.5 degrees backward

The heavier you pull or push the trigger,
the faster acceleration will be.

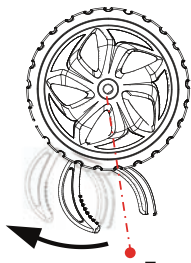
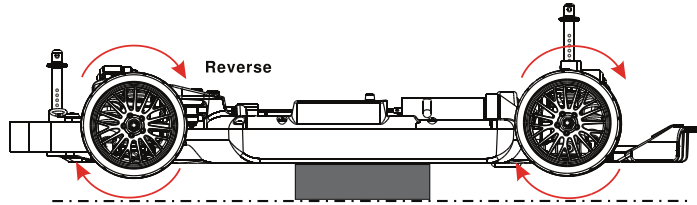
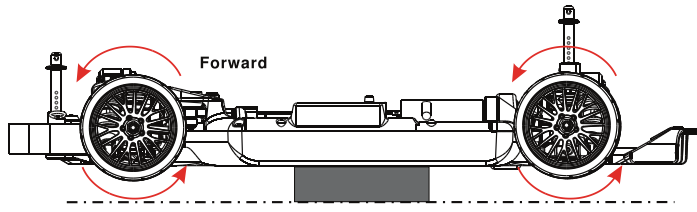

Forward

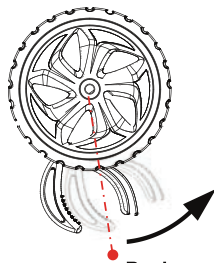

Brake

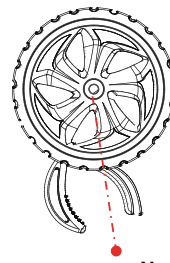

Neutral

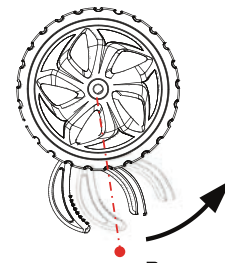

Reverse



ST.REV (CH1)

- Steering Trim (ST. Rev) is used to reverse the direction of servo movement.
- The ST.REV switches are the reverse buttons for Ch1. If the switch is up it indicates reverse, and the down indicates normal.

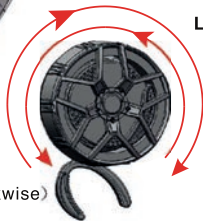

Left (Anti-clockwise)

Vehicle turning left when the control wheel is turned to the left (Steering Rev. At Normal position)

Vehicle turning right when the control wheel is turned to the right (Steering Rev. at Reverse position)

Right (clockwise)

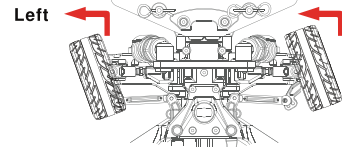

Left

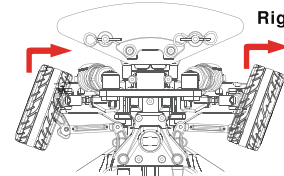

Right



TH.REV (CH2)

- The Throttle Rev. is used to reverse the direction of motor rotation.
- The TH.REV switches are the reverse buttons for CH2. If the switch is up it indicates reverse, and the down indicates normal.

CHANNEL REVERSE



Vehicle going forward
(Throttle Rev. at Normal position)

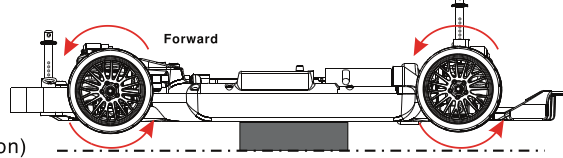

Forward



Vehicle going backwards
(Throttle Rev. at Reverse position)

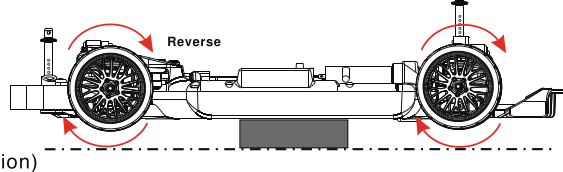

Reverse



Light Control Usage

As shown in picture: Connect the light wire correctly, and install the bodyshell.

Power on the transmitter, then switch on the car, press CH4 button (CH4 LED on), then the front and rear lights on. Press CH4 button again (CH4 LED off), the front and rear lights off.

Note: Once the lights of the car is abnormal, please adjust the positive and negative ports of the light connector and use the CH4 direct-reverse button to repair.

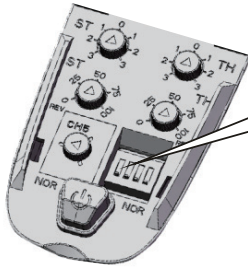
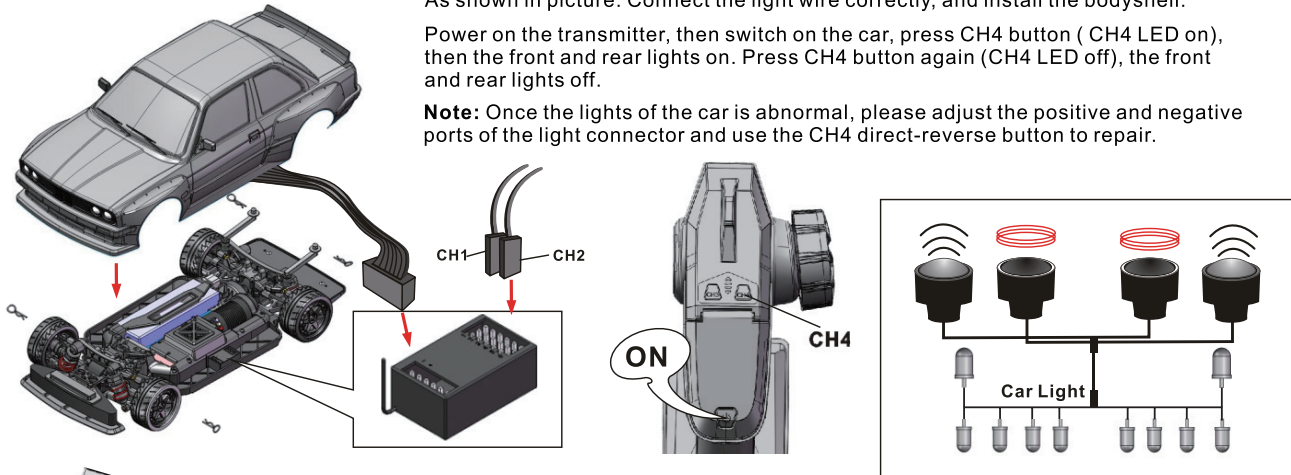

↔ Headlights Control positive and negative Switch (CH4)

- Factory Setting, Switch on and press CH4 button, the headlights are on. Press CH4 button on again, the headlights are off.
- Switch On, the headlights are on without pressing CH4 button, the headlights are off when pressing CH4 button. In this case, please push CH4 positive and negative Switch to set.

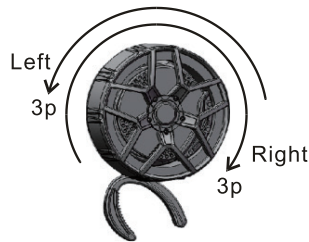

● Park Light

Turn the transmitter wheel left or right for three times, the emergency light (flash) is on. Turn three times again, the flash function is off.

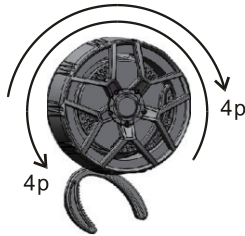

● Atmosphere lamp

Turn the transmitter wheel left or right continuously for 4 times, the atmosphere lamp (flash) is on. Then turn the transmitter wheel left or right continuously for 4 times again, the atmosphere lamp is off.

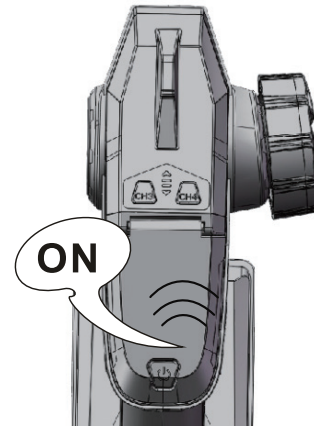
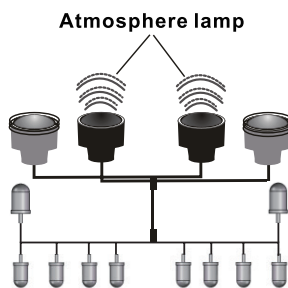
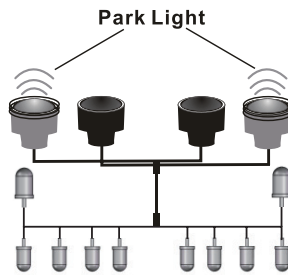

⚠ Note

Power on the transmitter, once no action within 12 minutes, the warning tone will be activated in 12 minutes and automatically power off the transmitter in 15 minutes.

Once everything is done, your car is ready to run. Hope you enjoy the fun in driving it!

Tip: Always turn off the receiver and then the transmitter when not in use. Clean the car before storage.

Vehicle Maintenance:

- 1). Please remove the battery pack plug or take it out, when the car is out of use.
- 2). Before each use, please redo the above steps and check all the parts condition if over wear.
- 3). Ensure the unused battery pack over-discharge (recommended to be above 40%), and keep in a dry and cool place, out of reach of children.
- 4). After each use, please carefully check all the parts condition, and repair or replace the worn part. Use a fine brush to sweep the sand, marl and other dirt inside the model, then wipe it cleanly by a soft cloth.





PLEASE NOTE:

Although the electronics are waterproof the rest of car can be subjected to damage if running in excessively wet or submerged conditions.

After Run

Switch off the receiver power, switch off the transmitter.
 Disconnect the battery and remove it from the vehicle, allow it to cool before recharging. If you have a second charged battery all ready to use, still allow the vehicle to cool slightly before continuing.

Regular maintenance

Frequently check the whole vehicle for loose or missing fixings. Use thread lock on any replacement screws into metal threads.
 Frequently check rotating parts are free from grass, string etc. that might bind their motion and over stress the motor or speed controller. Remove the wheels occasionally and check behind the mounting hex for obstructions or anything that might have been wrapped around the axle and caused extra drag.
 Check the gear mesh frequently and remove any stones or grit from gear teeth to prevent premature wear and damage.
 If the motor moves, or is removed for maintenance/exchange, the gear mesh will need to be set. Simply slacken the motor retaining screws and adjust the motor until there is just discernable backlash between pinion and spur teeth. If the gear is too tight or too loose the gears will be noisy and could be damaged.
 Shock absorbers will wear prematurely if used in dirty dusty conditions. Replace oil and seals as required to keep a smooth dampening action.

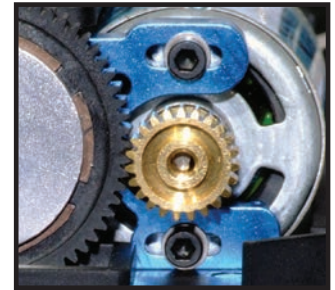

Trouble shooting guide.

<p>Short Runtime: Battery damaged/not charged Motor dirty or brushes worn Drivetrain binding</p>	<p>Sluggish Action: Motor dirty or brushes worn Bind in drive train Battery running low on power</p>	<p>Motor/ESC overheat: Over-gearred Binding transmission. Seized axle bearing. Motor binding</p>	<p>Motor spins but vehicle refuses to move: Gears damaged. Gears loose on shaft. Slipper clutch too loose. Drive shaft broken or missing.</p>	<p>Poor Range or fails to operate: Transmitter batteries low Vehicle Battery Low. Transmitter switched off Transmitter/receiver aerial not extended. ESC switched off or battery not connected. Loose connectors/wires. Water damage. Model electronics are not waterproof.</p>
--	--	---	--	---

Warranty

Due to the nature of this product and potential use FTX warrants it to be free of material and workmanship defects when new. FTX will at its sole discretion repair or replace defective components free of charge within 30 days from date of purchase. This warranty does not cover wear and tear, crash or impact damage, modifications, component water damage failure to perform maintenance or damage from improper use. Proof of purchase date will be required to action any warranty claims. In no case shall FTX's liability exceed the original cost of the purchased kit.

Instructions for disposal

Environmental Protection Notes & WEEE

The crossed-out wheeled bin symbol shown here, which may be found on the product itself, in the operating instructions or on the packaging, is in accordance with the Waste Electrical and Electronic Equipment (WEEE) Directive. Individual markings indicate which materials can be recycled and re-used. You can make an important contribution to the protection of our common environment by re-using the product, recycling the basic materials or recycling redundant equipment in other ways.

When this product comes to the end of its useful life, you must not dispose of it in the ordinary domestic waste. Many electrical items that we throw away can be repaired or recycled. Recycling items helps to save natural resources and also reduces the environmental and health impacts that are linked with sending electrical goods to landfill. The correct method of disposal is to take it to your local collection point for recycling electrical and electronic equipment. You can go to recycle-more.co.uk for details of locations.

Alternatively FTX can offer our customers free take-back of their WEEE on a like-for-like basis when they buy a new Electrical or Electronic product from us. For example, if a customer bought a new radio system from us or a dealer, we would accept their old radio and prevent it going into a landfill site by disposing of it safely. Customers must return their old WEEE item to us within 28 days of purchasing their new item.

Remove batteries from your device and dispose of them at your local collection point for batteries. If you don't know the location of your nearest disposal centre, please enquire at your local council office.



CML Distribution, Saxon House, Saxon Business Park, Hanbury Road,
 Bromsgrove, B60 4AD. WEE/GB4215VX





EXPLODED PARTS DIAGRAMS

Assembly Steps

1. Diff. Gear Assembly

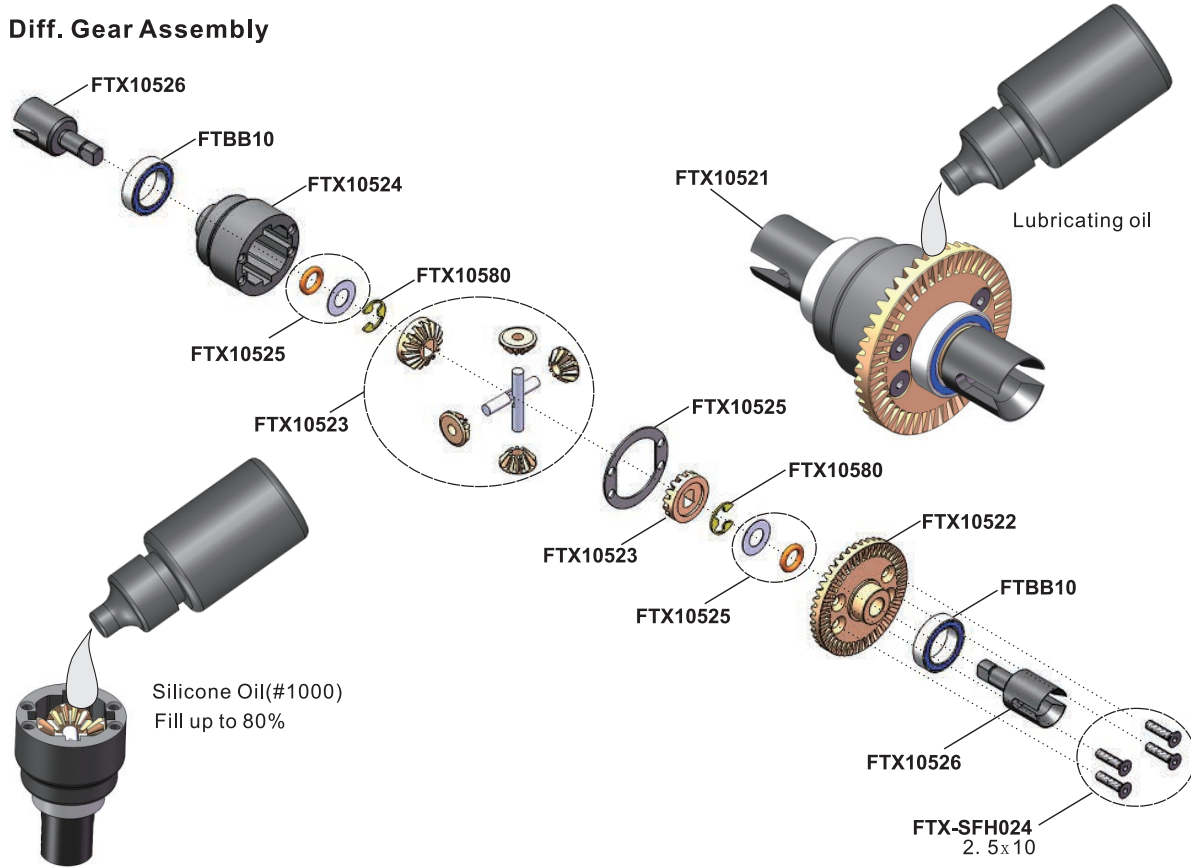

2. Diff Case/ Driveshaft Assembly

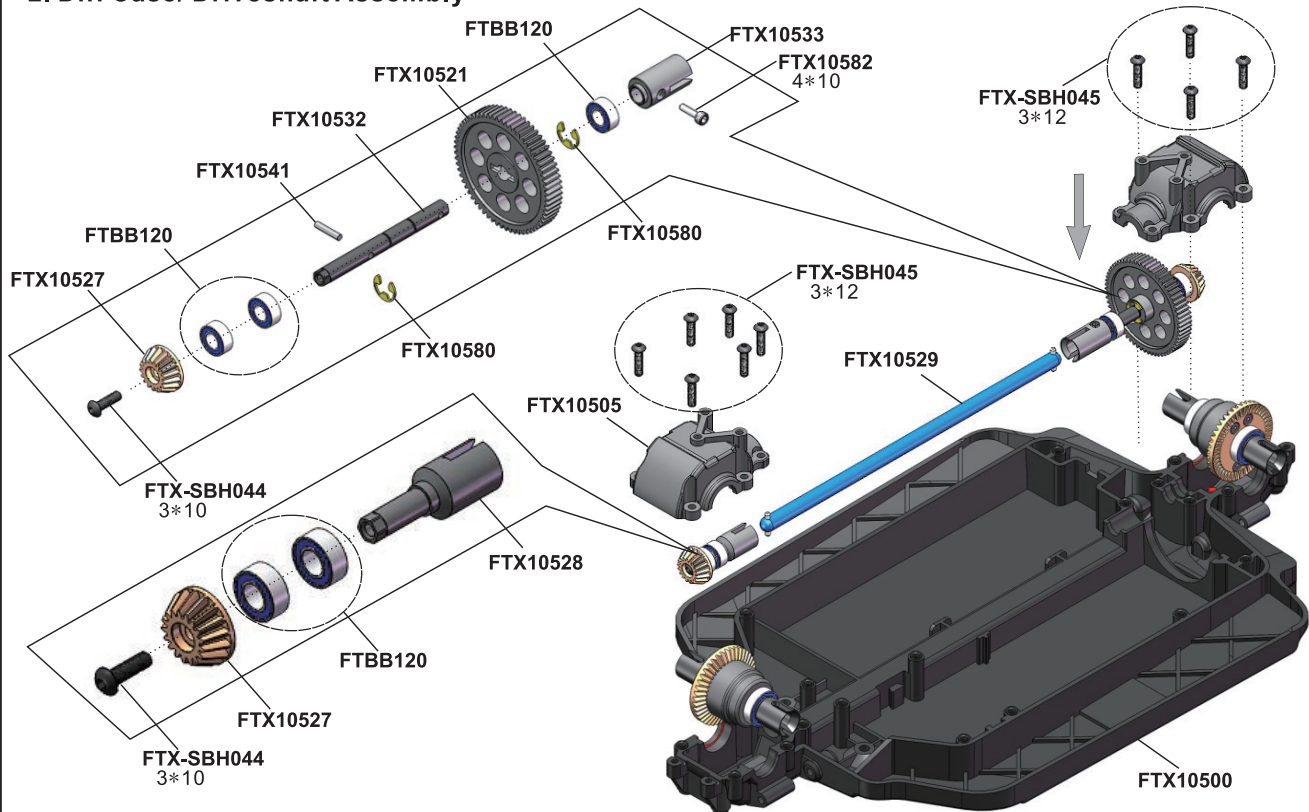



3. Motor Assembly

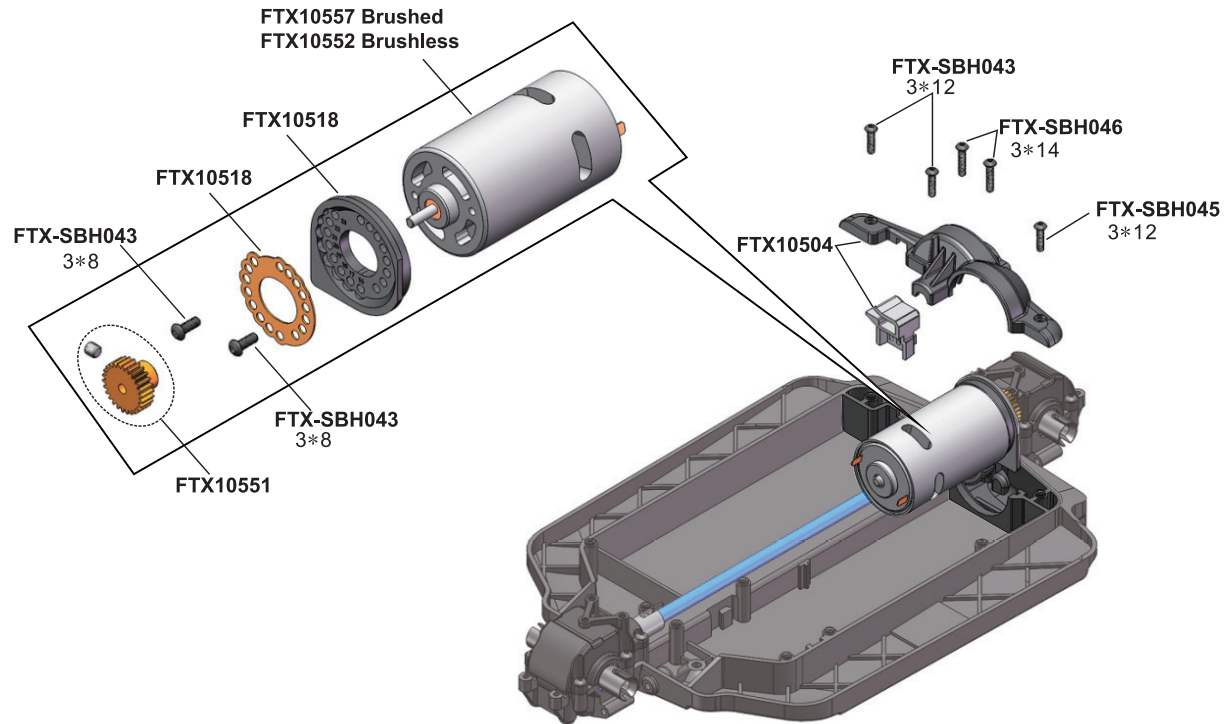

4. Front Shock Tower Assembly

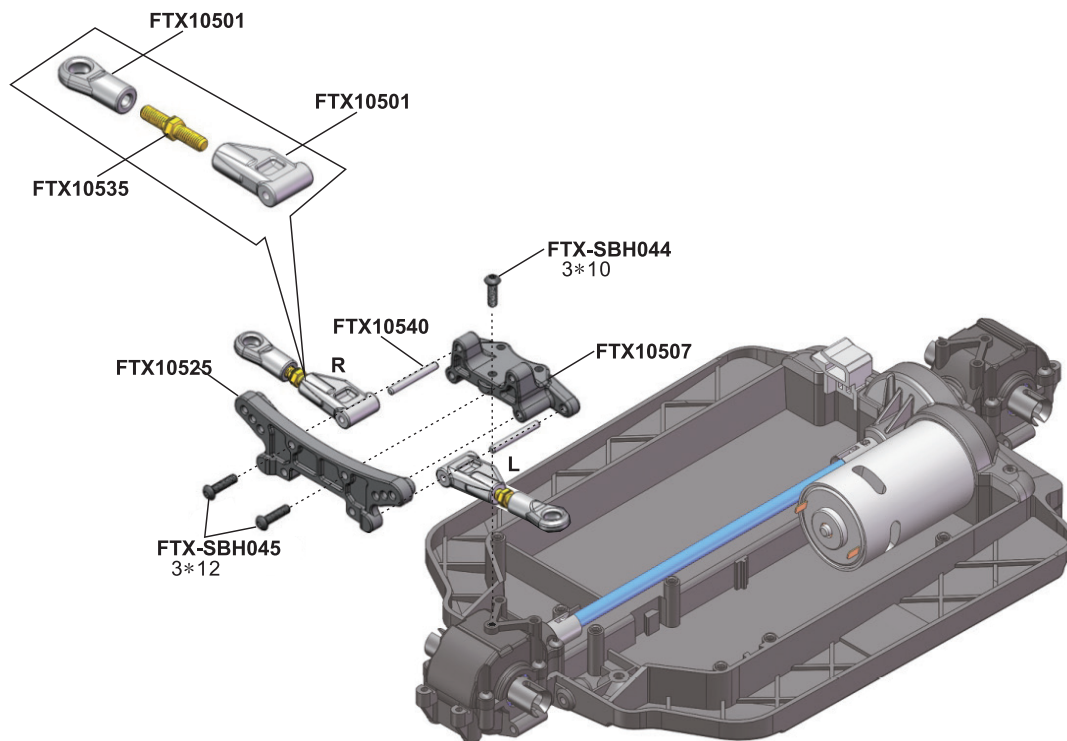



5. Rear Shock Tower Assembly

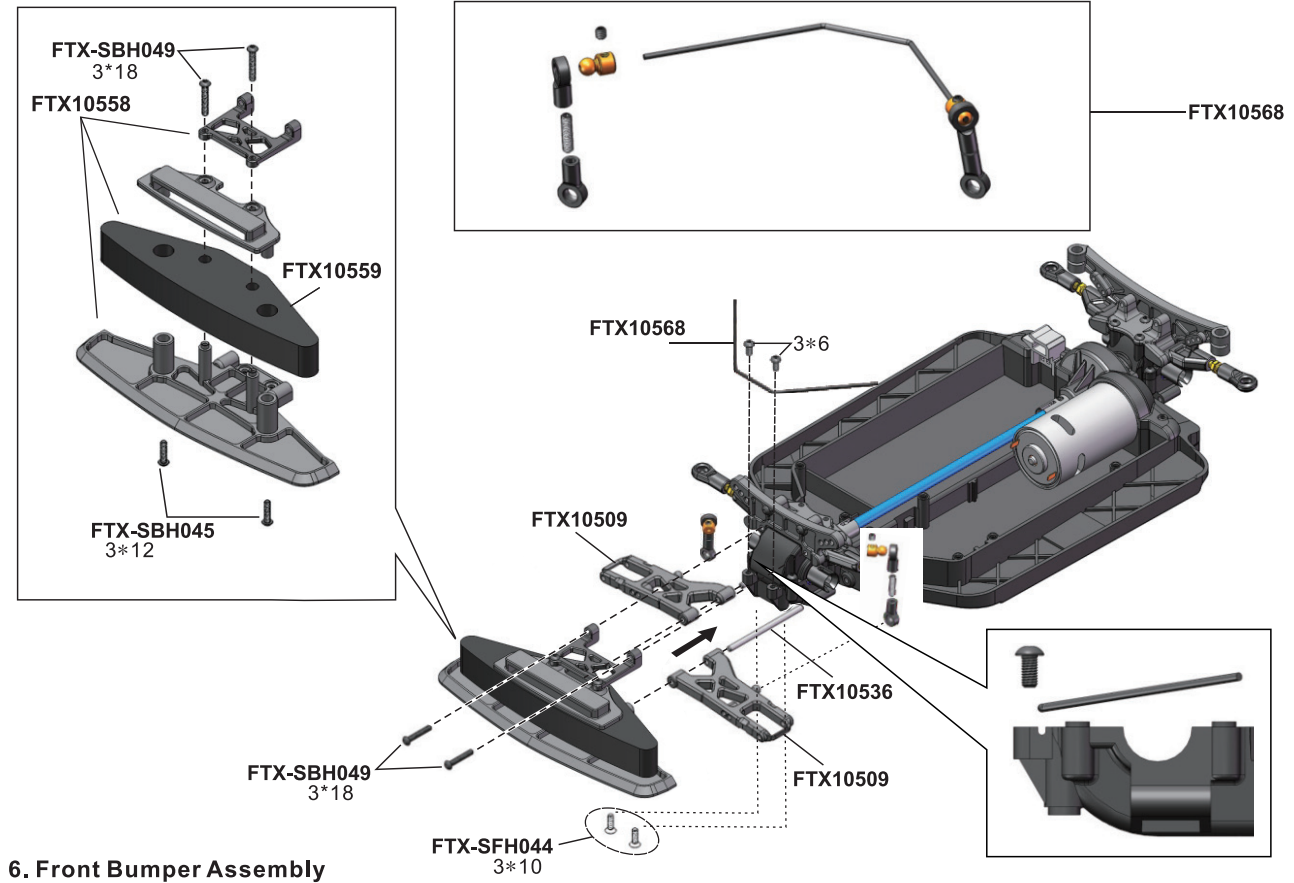
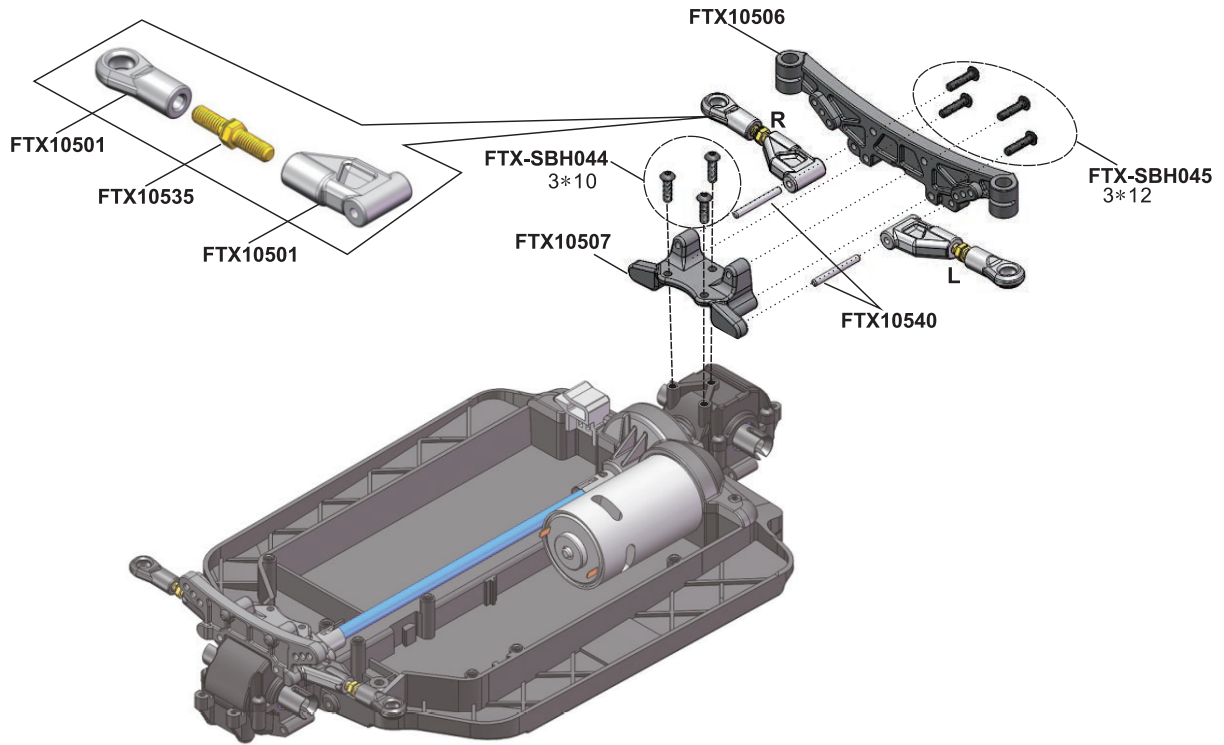

6. Front Bumper Assembly



7. Rear Bumper Assembly

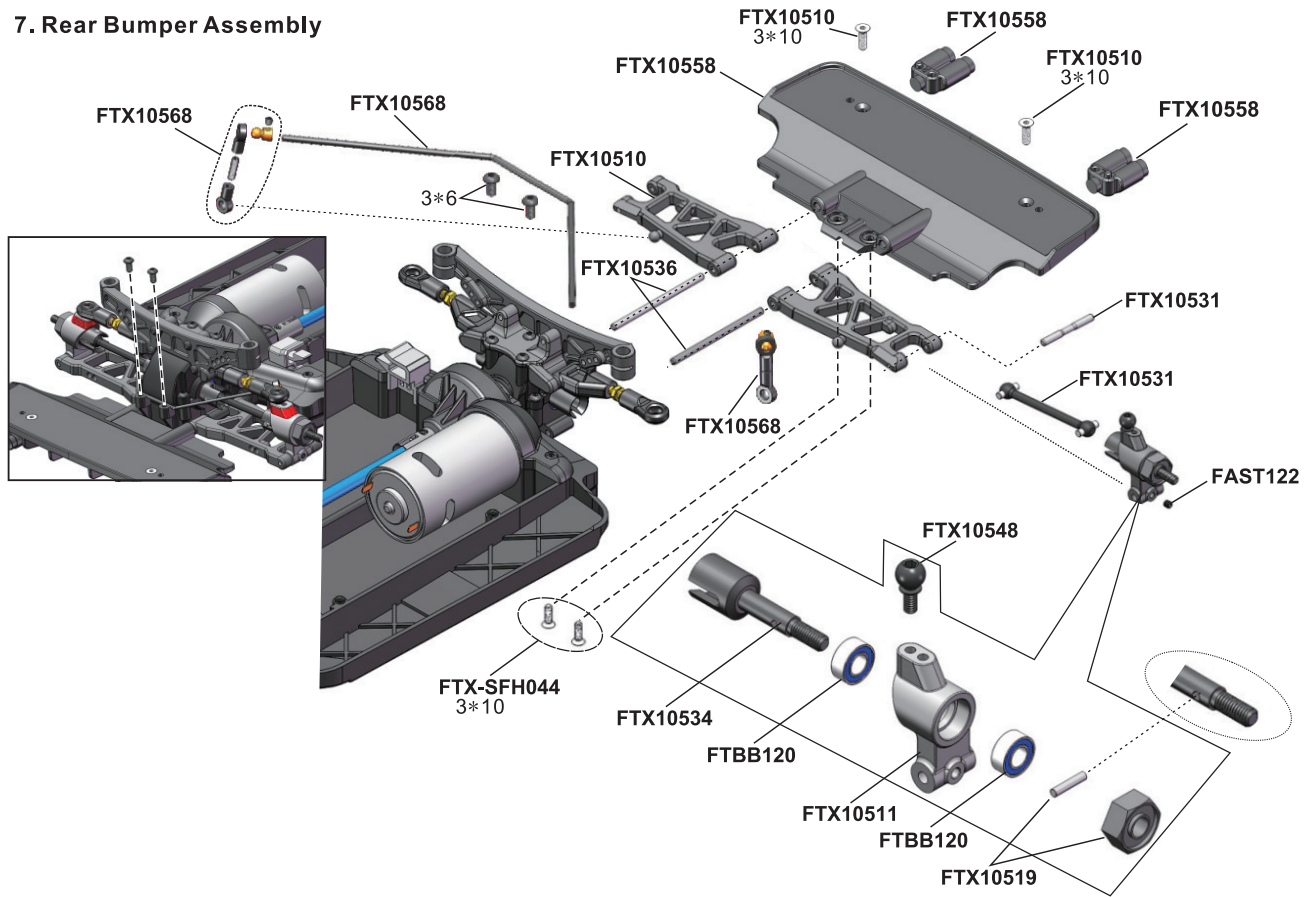

8. Front Drive Assembly

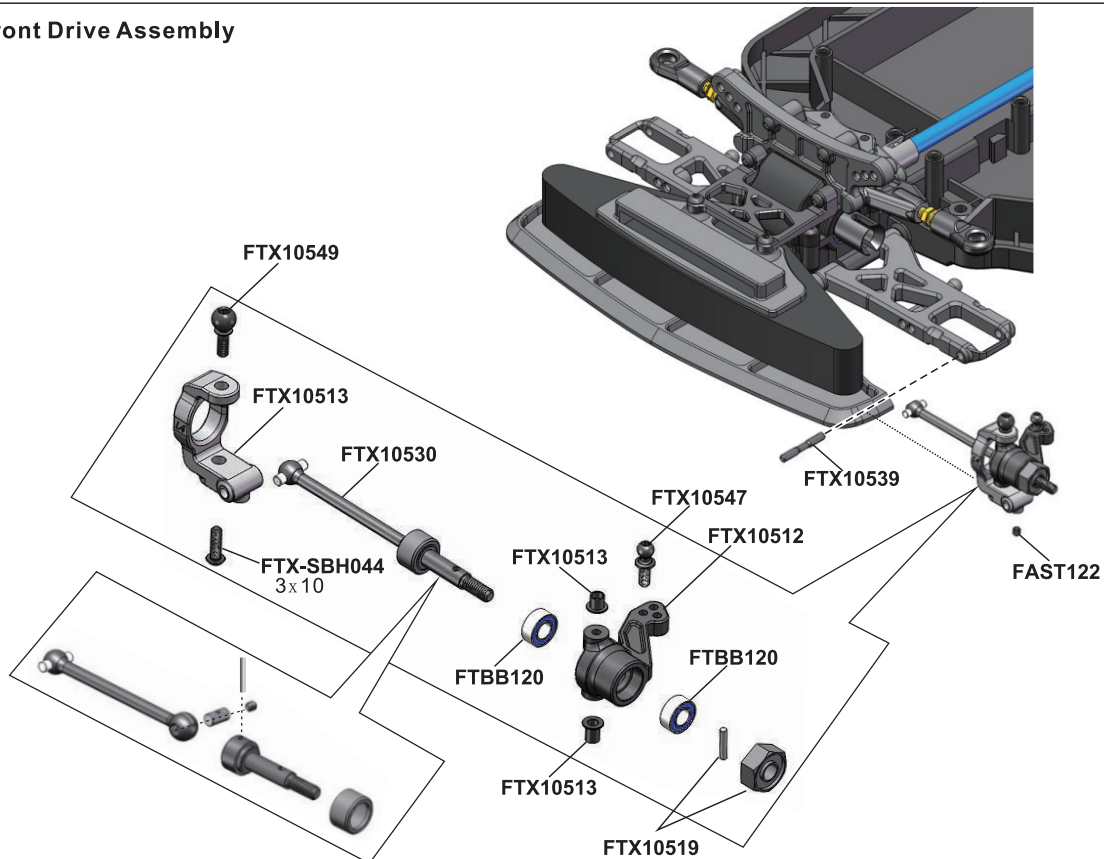



9. Shock Assembly

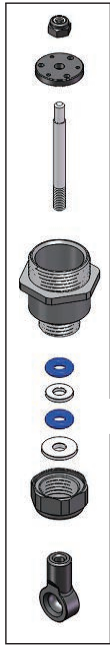

Silicone Oil(#800)
Fill up to 80%

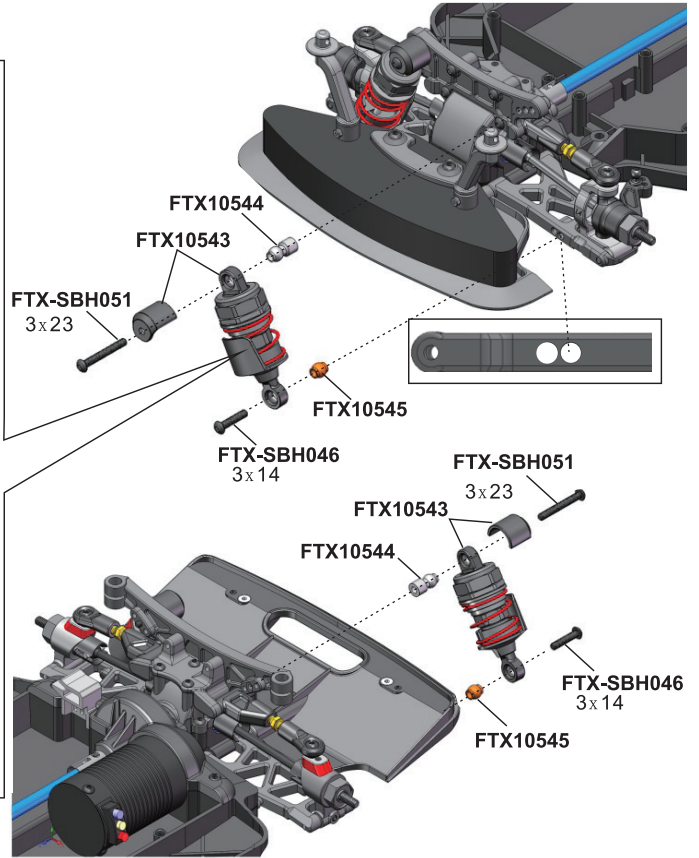
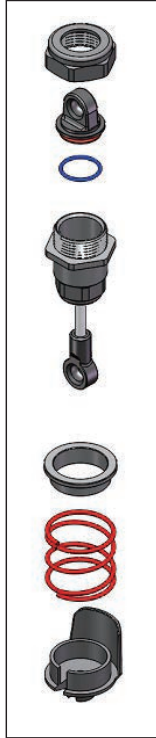

10. Steering Assembly

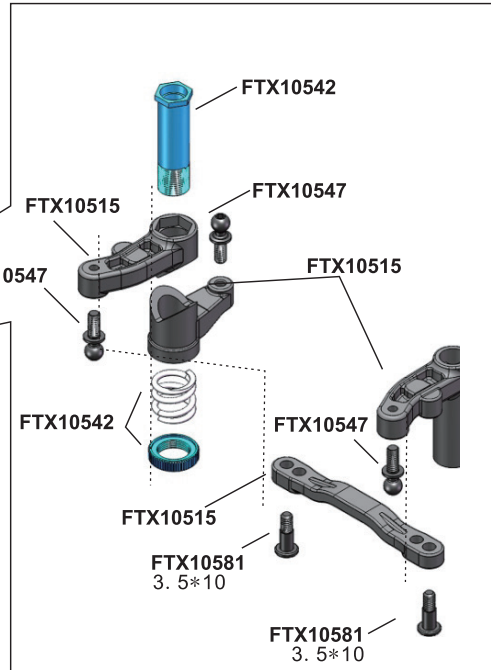
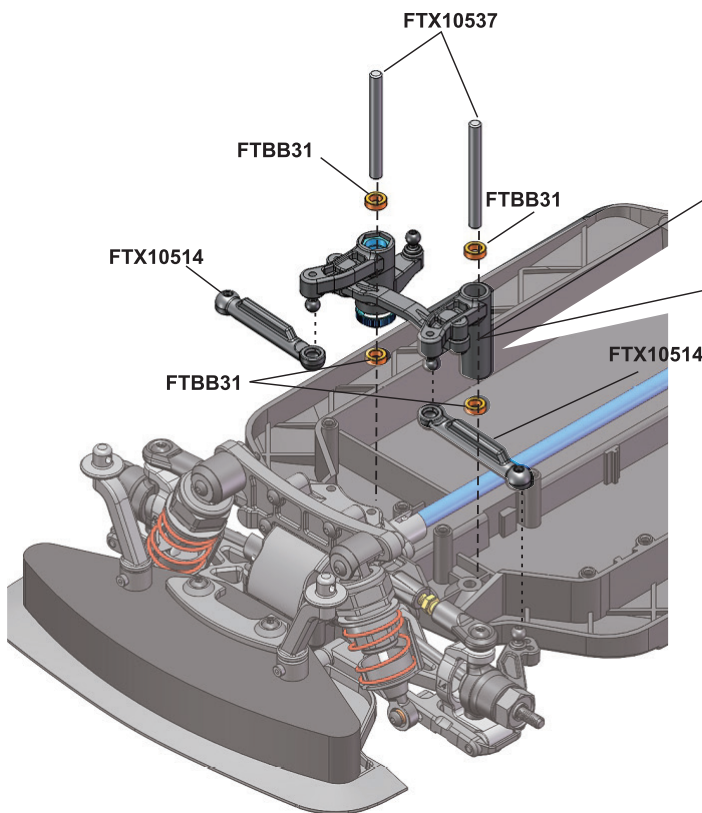



11. Front Support Plates Assembly

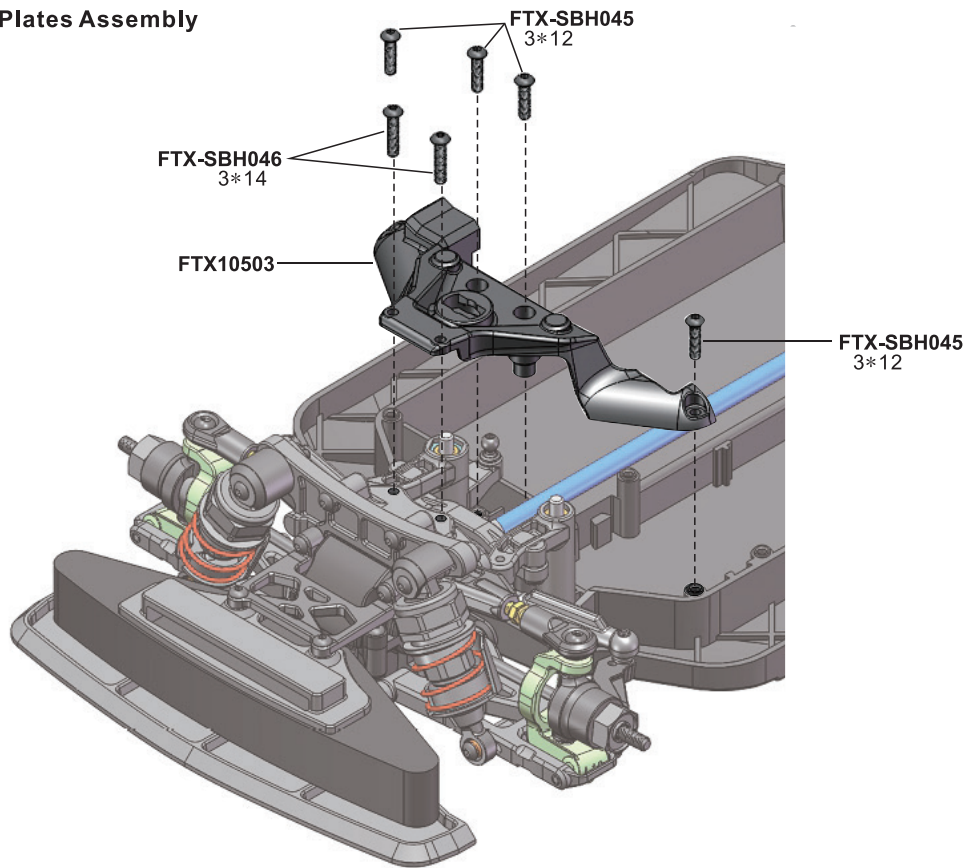

12. Wheels Assembly

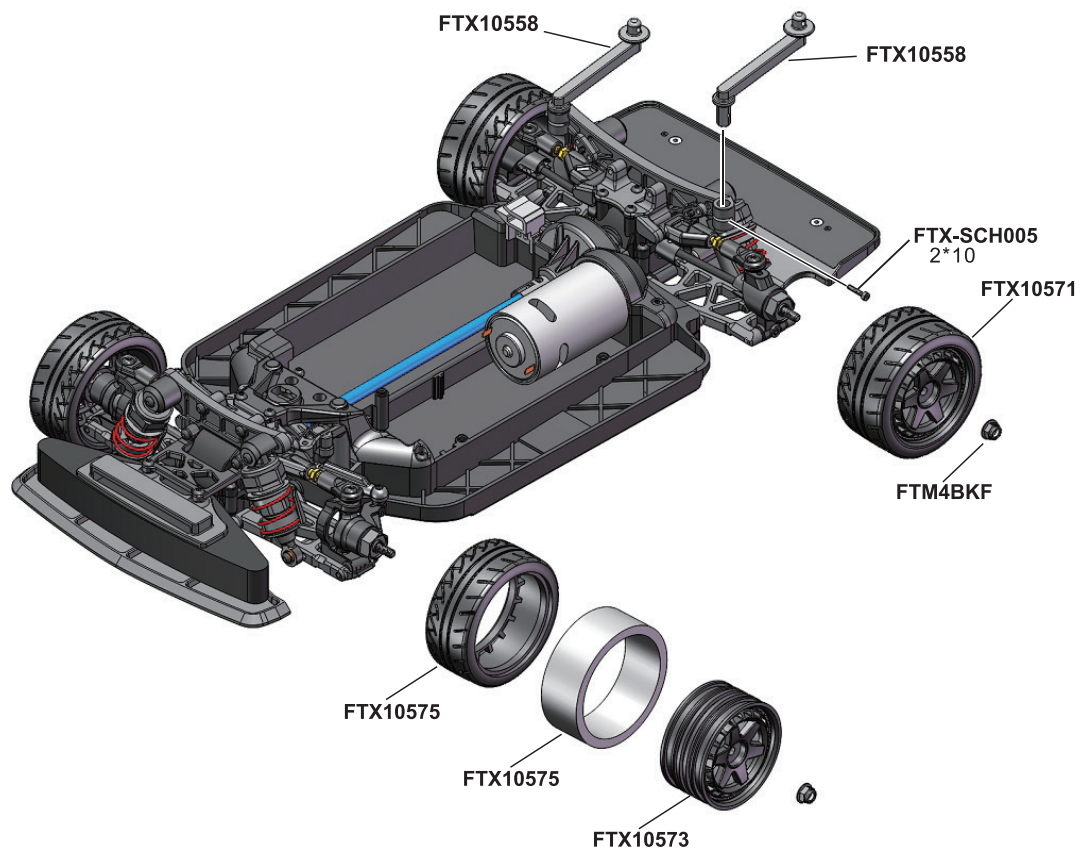



13. Servo /Electrical Parts Assembly

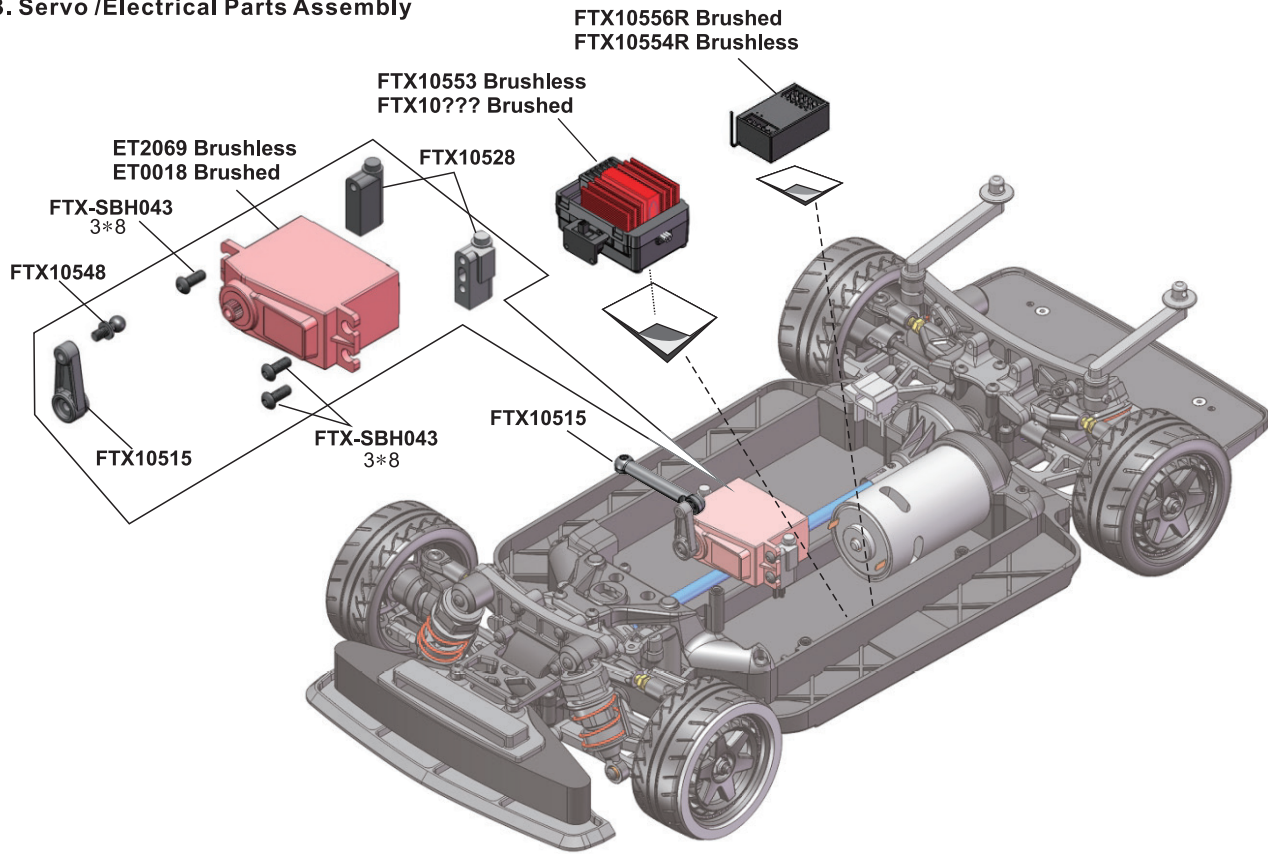

14. ESC cover/Battery Assembly

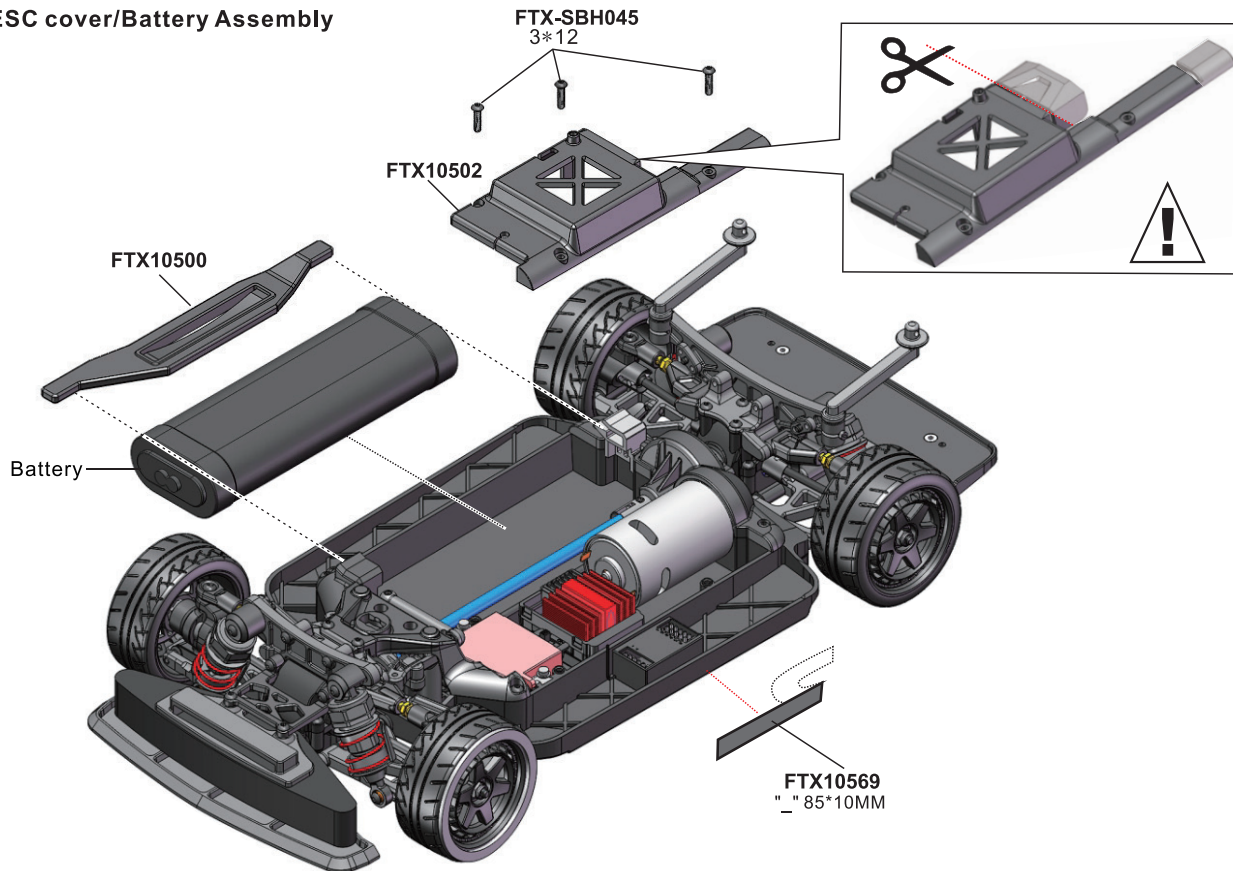



15. Body Assembly.

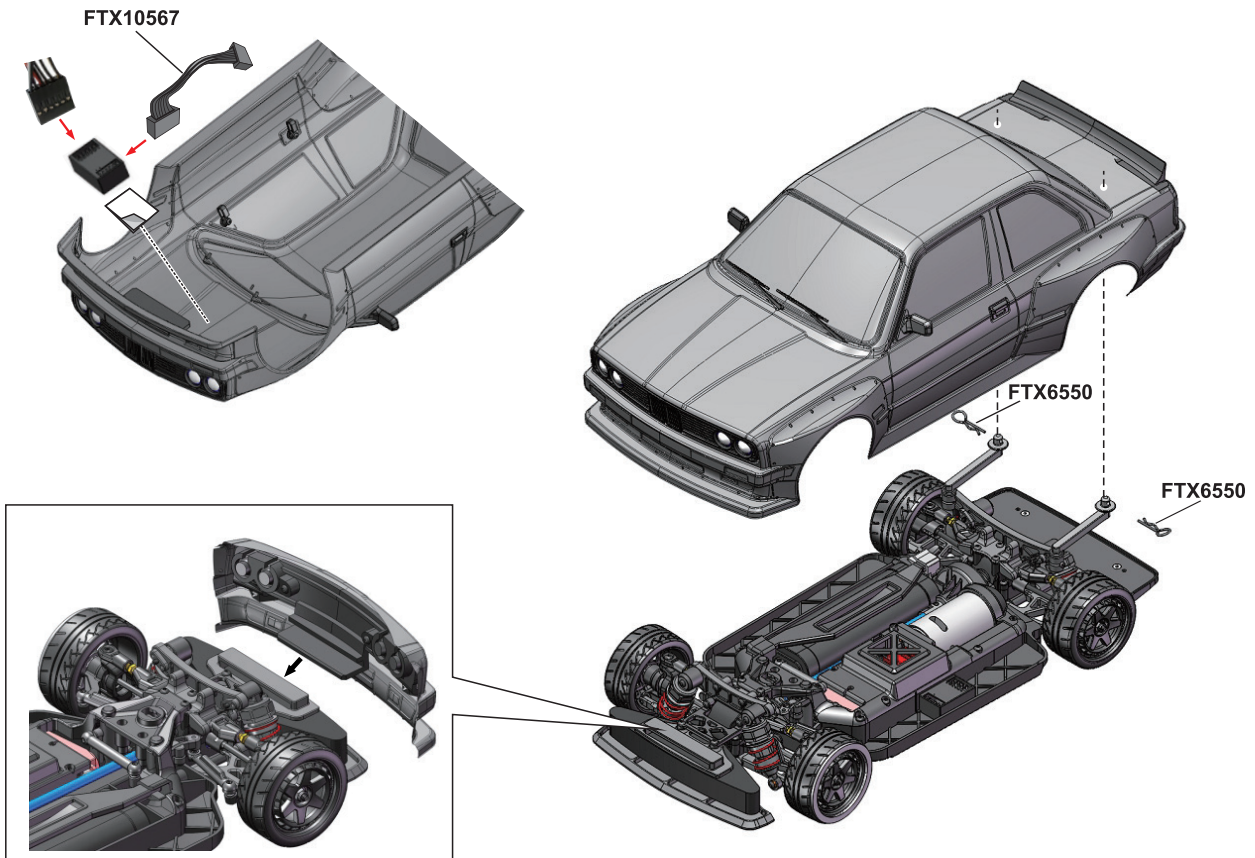
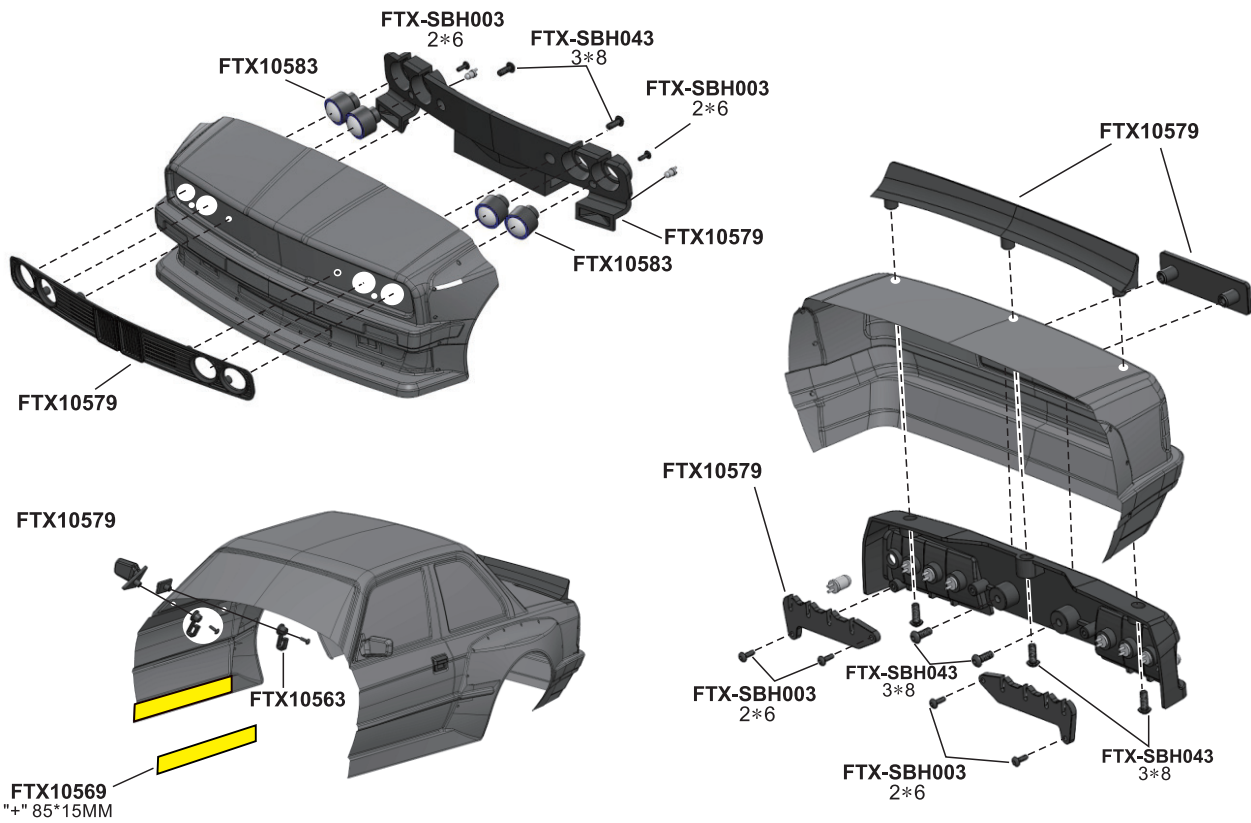

















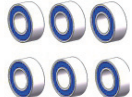

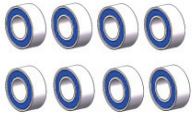



















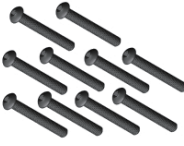









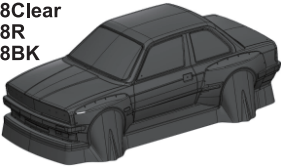

PARTS LISTING

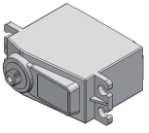
FTX10500  Chassis / Battery brace	FTX10501  Upper Sway Arm(F/R)	FTX10502  ESC Cover	FTX10503  Front Holder	FTX10504  Gear Cover
FTX10505  Gearbox Housing	FTX10506  Shock Tower	FTX10507  Shock Mount	FTX10509  Front Lower Sway Bar	FTX10510  Rear Lower Sway Bar
FTX10511  Rear Hub Carrier	FTX10512  Steering knuckle arms	FTX10513  Caster Block (R/L)	FTX10514  Steering Links Set	FTX10515  Steering Mount Set / Steering horn
FTX10558  Servo Mount	FTX10559  Motor Mount	FTX10517  Wheel Hex w/Pins	FTX10518  Wheel Hex w/Pins	FTX10519  Wheel Hex w/Pins
FTX10520  Complete differential	FTX10521  Main Spur gear (58T)	FTX10522  Diff Crown Gear (42T)	FTX10523  Diff Bevel Gear Set	FTX10524  Diff. Case
FTX10525  Diff Gasket & O Ring	FTX10526  Diff Output Cups	FTX10527  Drive Gear (17T)	FTX10528  Drive Output cups	FTX10529  Central Driveshaft
FTX10530  Front CVD Drive shaft	FTX10531  Rear shaft	FTX10532  Driveshaft	FTX10533  Centre Drive Output Cups	FTX10534  Wheel axle
FTX10535  Upper Link Turnbuckles (F/R)	FTX10536  Pin-3*54	FTX10537  Pin-4*40	FTX10538  Pin-3*28	FTX10539  Pin-3*23

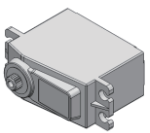

<p>FTX10538</p>  <p>Pin-3*28</p>	<p>FTX10539</p>  <p>Pin-3*23</p>	<p>FTX10540</p>  <p>Pin-2.5*22</p>	<p>FTX10541</p>  <p>Pin-2*10</p>	<p>FTX10542</p>  <p>Steering Saver Tube & Spring Set (metal)</p>
<p>FTX10543</p>  <p>Shock Absorber</p>	<p>FTX10544</p>  <p>Shock Pivot Ball (upper)</p>	<p>FTX10545</p>  <p>Shock Pivot Ball (lower)</p>	<p>FTBB31</p>  <p>Ball Bearing φ4*φ7*2.5</p>	<p>FTBB10</p>  <p>Ball Bearing φ10*φ15*4</p>
<p>FTBB120</p>  <p>Ball Bearing φ5*φ10*4</p>	<p>FTX10546</p>  <p>Ball Head Screw φ4.8*5</p>	<p>FTX10547</p>  <p>Ball Head Screw φ4.8*7</p>	<p>FTX10548</p>  <p>Ball Head Screw φ6.8*6</p>	<p>FTX10549</p>  <p>Ball Head Screw φ6.8*8</p>
<p>FTX10570</p>  <p>Front Wheel Complete</p>	<p>FTX10571</p>  <p>Rear Wheel Complete</p>	<p>FTX10572</p>  <p>Drift Wheel Complete</p>	<p>FTX10573</p>  <p>Front Wheel Rim</p>	<p>FTX10574</p>  <p>Rear Wheel Rim</p>
<p>FTX10575</p>  <p>Front Tire W / Foam</p>	<p>FTX10576</p>  <p>Rear Tire W / Foam</p>	<p>FTX10550</p>  <p>Bumper Foam</p>	<p>FTM4BKF</p>  <p>Flange Nut M4</p>	<p>FTX10580</p>  <p>E-Clips φ4.0mm</p>
<p>FAST122</p>  <p>Grub Hex Screw 3*3</p>	<p>FTX-SBH043</p>  <p>Button Head 3*8</p>	<p>FTX-SBH044</p>  <p>Button Head 3*10</p>	<p>FTX-SBH045</p>  <p>Button Head 3*12</p>	<p>FTX-SBH046</p>  <p>Button Head 3*14</p>
<p>FTX-SBH051</p>  <p>Button Head 3*23</p>	<p>FTX-SCH004</p>  <p>Column Head 2*8</p>	<p>FTX-SBH043</p>  <p>Flat Head 2.5*10</p>	<p>FTX-SFH044</p>  <p>Flat Head 3*10</p>	<p>FTX-SBH003</p>  <p>Button Head 2*6</p>

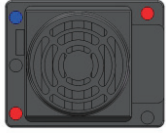
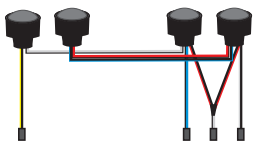
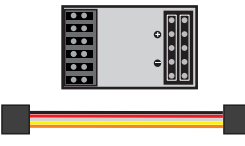

FTX10579  Body Accessories	FTX6550  Body Clip Ø1.2mm	FTX10577R FTX10577BK  PC Body(Assembled)	FTX10578Clear FTX10578R FTX10578BK  PC Body/Stickers	
FTX10557 (Brushed)  Motor(RC550-8517)	ET0018 (Brushed)  Servo-9KG	FTX10556 (Brushed)  (without Gyro) Radio/Receiver	FTX10556R (Brushed)  (without Gyro) DVC Receiver	FTX10584 (Brushed)  WP1040 Speed Control
FTX10552 (Brushless)  Brushless Motor 3300kv	ET2069  Servo-15KG	FTX10554 (Brushless)  Radio/Receiver	FTX10554-R (Brushless)  Ftx Stinger Receiver Only	FTX10553 (Brushless)  ESC Brushless-60A
FTX10583 (Brushed)  Light	FTX10567  Light Control Box	FTX10568  Sway Bar + Links		

OPTIONAL UPGRADABLE PARTS

FTX10590  Motor Mount(AL.)	FTX10591  Motor Gear (23T/29T)	FTX10592  Rear Axle Mount(AL.)	FTX10593  Steering Mount(AL.)	FTX10594  Caster Block(AL.)
FTX10596  Aluminium Shock Absorber Set				



NOTES:

A large rectangular area with a thin black border, containing 24 horizontal dashed lines for taking notes.



EVO30



www.ftx-rc.com



FTX is an exclusive brand of CML Distribution, Saxon House, Saxon Business Park,
Hanbury Road, Bromsgrove, Worcestershire, B60 4AD England.
E-mail: info@ftx-rc.com